

memmert

VO



OPERATING MANUAL

VACUUM OVEN VO

MADE IN GERMANY.

www.memmert.com

Manufacturer and customer service

MEMMERT GmbH + Co. KG
Willi-Memmert-Straße 90-96
91186 Büchenbach
Germany

Phone: +49 (0)9122 925-0
Fax: +49 (0)9122 14585
E-mail: sales@memmert.com
Internet: www.memmert.com

Customer service:

Service hotline: +49 (0)9171 9792 911
Service fax: +49 (0)9171 9792 979
E-mail: service@memmert.com

When calling for service enquiries, please state the appliance number given on the name-plate (see page 15).

Shipping address for repairs:

Memmert GmbH + Co. KG
Customer service
Willi-Memmert-Str. 90-96
DE-91186 Büchenbach
Germany

Please contact our customer service department before sending appliances for repair or before returning equipment, or the shipment may be refused.

About this manual

Purpose and target audience

This manual describes the assembly, function, transport, putting into operation, operation, troubleshooting, maintenance and decommissioning/disposal of the vacuum oven VO. It is intended for use by trained personnel of the owner, who have the task of operating and/or maintaining the respective appliance.

If you are asked to work on the appliance, read this manual carefully before starting. Familiarise yourself with the safety regulations. Only perform work that is described in this manual. If there is something you do not understand, or certain information is missing, ask your manager or contact the manufacturer. Do not do anything without authorisation.

Versions

The appliances are available in different configurations and sizes. If specific equipment features or functions are available only for certain configurations, this is indicated at the relevant points in this manual.

The functions described in this manual refer to the latest firmware version.

Due to individual configurations and sizes, illustrations in this manual may be slightly different to the actual appearance. Function and operation are identical.

Other documents to be observed:

- ▶ Observe the relevant manual when operating the appliance with MEMMERT AtmoCONTROL computer software. Click on “Help” on the AtmoCONTROL menu bar to open the AtmoCONTROL software manual.
- ▶ Please refer to the separate service manual for service and repair work (see page 64).

Storage and resale

This operating manual belongs with the appliance and should always be stored where persons working on the appliance have access to it. It is the owner's responsibility to ensure that persons who are working on or are going to work on the appliance know where to find the operating manual. We recommend that it is always stored in a protected location close to the appliance. Make sure that the operating manual is not damaged by heat or humidity. If the appliance is resold or transported and then set up again at a different location, the operating manual must remain with it.

For the current version of this operating manual in PDF format, please go to <http://www.memmert.com/en/service/downloads/user-manual/>.

Contents

1. For your safety	6
1.1 Terms and signs used.....	6
1.2 Product safety and dangers.....	6
1.3 Requirements of the operating personnel	7
1.4 Responsibility of the owner	8
1.5 Changes and alterations.....	8
1.6 Behaviour in case of malfunctions and irregularities	8
1.7 Switching off the appliance in an emergency.....	8
2. Design and description	9
2.1 Design	9
2.2 Intended use	10
2.3 Function	10
2.4 Materials used.....	12
2.5 Electrical equipment.....	12
2.6 Connections and interfaces	12
2.7 Designation (nameplate)	15
2.8 Technical data.....	16
2.9 Declaration of conformity.....	17
2.10 Ambient conditions	18
2.11 Scope of delivery	18
2.12 Optional accessories	18
3. Delivery, transport and setting up	19
3.1 Delivery	20
3.2 Transport.....	20
3.3 Unpacking	20
3.4 Storage after delivery	20
3.5 Setting up	21
4. Putting into operation	25
4.1 Connecting the appliance.....	25
4.2 Install suction	27
4.3 Insert thermoshelves	28
4.4 Switching on	29
5. Operation and control	30
5.1 Operating personnel.....	30
5.2 Opening the door.....	30
5.3 Operating the appliance.....	31
5.4 Temperature monitoring	37
5.5 Pressure monitoring	41
5.6 Graph	42
5.7 Ending operation.....	43
6. Malfunctions, warning and error messages	44
6.1 Warning messages of the monitoring function	44
6.2 Malfunctions, operating problems and appliance errors	45
6.3 Power failure	47

7. Menu mode	48
7.1 Overview	48
7.2 Basic operation in menu mode using the example of language selection.....	49
7.3 Setup.....	50
7.4 Date and time	53
7.5 Calibration.....	54
7.6 Program	59
7.7 Sounds	60
7.8 Logging.....	61
7.9 USER ID	62
8. Maintenance and Servicing	63
8.1 Cleaning	63
8.2 Regular maintenance.....	63
8.3 Repairs and Service.....	63
9. Storage and disposal	64
9.1 Storage.....	64
9.2 Disposal.....	64
Index	65

1. For your safety

1.1 Terms and signs used

In this manual and on the appliance itself, certain common terms and signs are used to warn you of possible dangers or to give you hints that are important in avoiding injury or damage. Observe and follow these notes and regulations to avoid accidents and damage. These terms and signs are explained below.

1.1.1 Terms used

⚠ WARNING

Warns of a dangerous situation that might lead to death or serious injuries

⚠ CAUTION

Warns of a dangerous situation that might lead to moderate or minor injuries

NOTICE

Warns of material damage

1.1.2 Signs used

Signs used				
				
Danger of electrocution	Danger of explosion	Dangerous gases/vapours	Danger of burns	Danger of toppling over
				
Gas bottles	Follow the instructions!	Wear gloves	Observe information in separate manual	Disconnect the mains plug

1.2 Product safety and dangers

The appliances described in this manual are technically sophisticated, manufactured using high-quality materials and subject to many hours of testing in the factory. They reflect the state of the art and comply with recognised technical safety regulations. However, there are still risks involved, even when the appliances are used as intended. These are described below.

⚠ WARNING

After removing covers, live parts may be exposed. Touching these can lead to an electric shock. Disconnect the mains plug before removing any covers. Work on the electrical system must only be performed by qualified electricians.

**⚠ WARNING**

Toxic gases or vapours may be produced in certain applications. These can escape from the vacuum pump into the room. This can injure people nearby. The appliance may only be used for such applications if a suction is attached to the vacuum pump used, which reliably keeps toxic gases or vapours away from people. Observe the respective national regulations for occupational safety and environmental protection.

⚠ WARNING

Depending on operation, the surfaces in the interior of the appliance and the chamber load may still be very hot after the appliance is switched off. Touching these surfaces can cause burns. Wear heat-resistant protective gloves or wait until the appliance cools down before touching.

**⚠ WARNING**

Gas bottles may burst or explode at high temperatures. Keep the gas bottles away from open flames. Store gas bottles below 50 °C and ensure that the location is always well ventilated. Prevent water from penetrating as well as backflow into the gas bottles. It is essential that you read the safety notes and instructions of the gas supplier.

1.3 Requirements of the operating personnel

The appliance may only be operated and maintained by persons who are of legal age and have been instructed accordingly. Personnel who are to be trained, instructed or who are undergoing general training may only work with the appliance under the continuous supervision of an experienced person.

Repairs may only be performed by qualified electricians. The regulations in the separate service manual must be observed.

1.4 Responsibility of the owner

The owner of the appliance

- ▶ is responsible for the flawless condition of the appliance and for it being operated in accordance with its intended use (see page 8);
- ▶ is responsible for ensuring that persons who are to operate or service the appliance are qualified to do this, have been instructed accordingly and are familiar with the operating instructions at hand;
- ▶ must know about the applicable guidelines, requirements and operational safety regulations, and train staff accordingly;
- ▶ is responsible for ensuring that unauthorised persons have no access to the appliance;
- ▶ is responsible for attaching a suction to the vacuum pump used if toxic gases or vapours may arise as a result of the process;
- ▶ is responsible for ensuring that the maintenance plan is adhered to and that maintenance work is carried out properly (see page 64);
- ▶ has to ensure that the appliance and its surroundings are kept clean and tidy, for example through corresponding instructions and inspections;
- ▶ is responsible for ensuring that personal protective clothing is worn by operating personnel, e.g. work clothes, safety shoes and protective gloves.

1.5 Changes and alterations

No unauthorised changes or alterations may be made to the appliance. No parts may be added or inserted which have not been approved by the manufacturer.

Unauthorised changes or alterations result in the CE declaration of conformity losing its validity, and the appliance may no longer be operated.

The manufacturer is not liable for any damage, danger or injuries that result from unauthorised changes or alterations, or from non-compliance with the provisions in this manual.

1.6 Behaviour in case of malfunctions and irregularities

The appliance may only be used in a flawless condition. If you as the operator notice irregularities, malfunctions or damage, immediately take the appliance out of service and inform your superior.

i You can find information on troubleshooting from page 45.

1.7 Switching off the appliance in an emergency

Press the main switch on the ControlCOCKPIT (Fig. 1) and disconnect the power plug. This disconnects the appliance from the power supply at all poles.

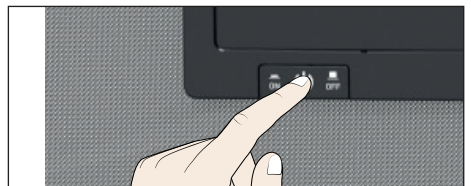

*Fig. 1
Switch off the appliance by pressing the main switch*

2. Design and description

2.1 Design



Fig. 2 Design

1 ControlCOCKPIT with capacitive function keys and LCD displays (see page 32)

2 Vacuum oven VO

3 Thermoshelves

4 Main switch Pump module

5 Pump module

2.2 Intended use

Vacuum ovens VO are used for drying, testing, moisture determination, airtight storage, curing and degassing of substances or materials under vacuum, which are used in the procedures and specifications described in the operating instructions.

The appliance is not explosion-proof. The use of explosive substances or materials is abusive and can lead to hazards or damage. The appliance may only be loaded with materials and substances which cannot form any explosive vapours at the set temperature and which cannot explode, burst or ignite.

2.3 Function

The devices of the VO series (Fig. 3 ①) can generate a vacuum in working chamber③ in conjunction with Memmert pump module ② or another suitable vacuum pump. The vacuum inlet on the back of appliance ④ evacuates the working chamber through the pump.

Optionally, the working chamber can be supplied with inert gas through a connection on the rear of the appliance ⑤⑥.

For temperature control thermal plates with electronic contacts are inserted into tube ⑦. If the electronic contacts are connected to the connections in rear panel ⑧, the thermoshelves can emit heat by direct contact with the load.

If toxic gases or vapours may be produced in the intended application, these must be safely discharged by the customer via an extraction system and cleaned if necessary ⑨.

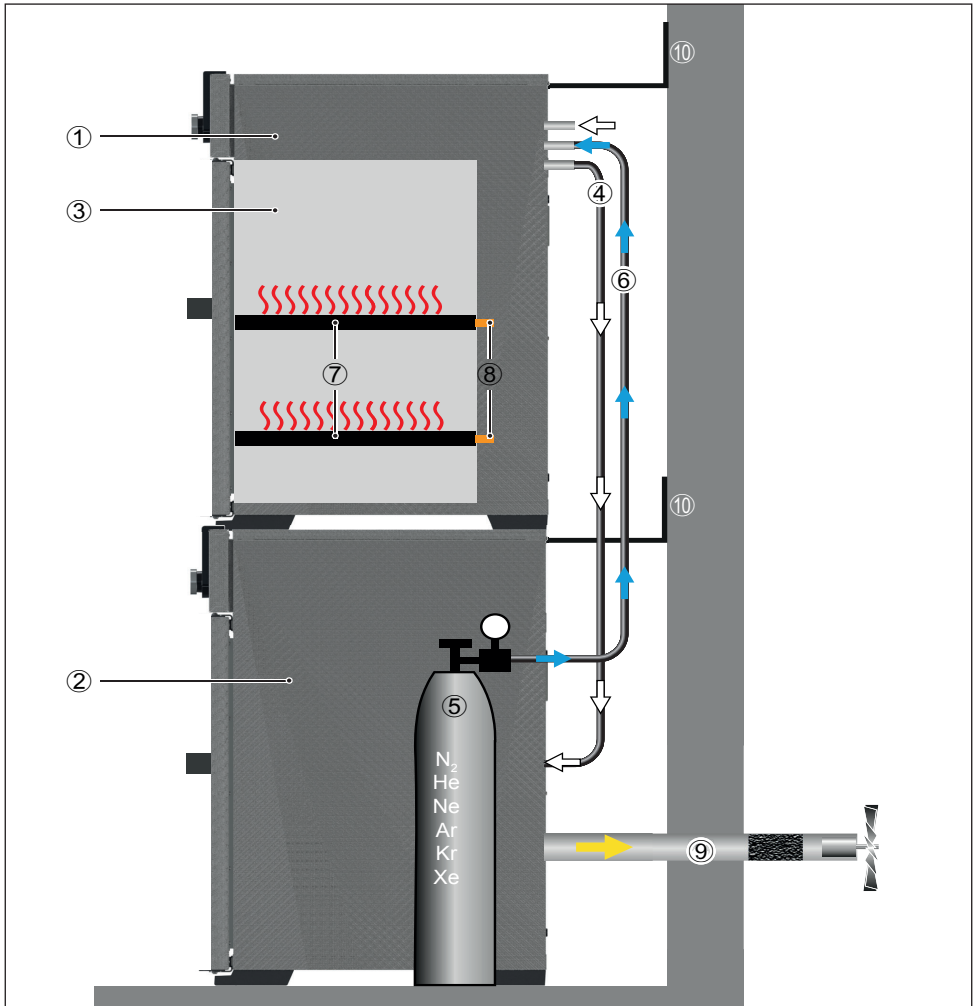

Fig. 3 Function of vacuum ovens VO in conjunction with a pump module

- 1 VO
- 2 Vacuum pump
- 3 VO working chamber
- 4 Hose connection between VO and vacuum pump
- 5 Gas cylinder (inert gas, optional)
- 6 Inert gas supply
- 7 Thermoshelves
- 8 Contacting the Thermoshelves in the appliance
- 9 Suction (required if toxic gases or vapours may be produced as a result of the process)
- 10 Wall mounting (tilt protection, see page 23)

2.4 Materials used

Component	Materials
Housing	Stainless steel (W.St.Nr. 1.4016)
Piping	Stainless steel (W.St.Nr. 1.4571)
Interior	Stainless steel (W.St.Nr. 1.4404), which stands out through its high stability, optimal hygienic properties and corrosion-resistance towards many (but not all!) chemical compounds (caution for example with chlorine compounds).
Thermoshelves	Aluminium. The vulcanised heating mat covered with stainless steel on the underside of the thermoshelf is made of silicone.
Plug connection of thermoshelf and rear flange socket	Ryton R4 (GF-PPS plastic) or Peek 450GL30
Seals in solenoid valves and flange sockets	Fluorocarbon FKM / FPM (Viton)
Door seal	Silicone

A resistance table for all these materials can be requested from the company MEMMERT.

2.5 Electrical equipment

- ▶ Operating voltage and current consumption: See nameplate
- ▶ Protection class I, i.e. operating insulation with PE conductor in accordance with EN 61010
- ▶ Protection class IP 20 acc. to EN 60529
- ▶ Interference suppression acc. to EN 55011 class B
- ▶ Appliance fuse: Safety fuse 250 V/15 A, quick-blow
- ▶ The temperature sensor is equipped with a 125 mA miniature fuse.

2.6 Connections and interfaces

2.6.1 Electrical connection

This appliance is intended for operation on an electrical power system with a system impedance Z_{\max} of a maximum of 0.292 ohm at the point of transfer (service line). The operator must ensure that the appliance is operated only on an electrical power system that meets these requirements. If necessary, you can ask your local energy supply company what the system impedance is.

Observe the country-specific regulations when making connections (e.g. in Germany DIN VDE 0100 with earth leakage circuit breaker).

2.6.2 Fresh air, inert gas and vacuum connection

At the left rear post are the connections for the inlet of fresh air or inert gas (optional) and the connection for the vacuum pump (DN 16 KF, Fig. 4 and Fig. 5).

Fresh air

The fresh air connection has two functions. On the one hand, the device is ventilated via the connection and thus the negative pressure is adapted to the atmospheric pressure. On the other hand, the connection is opened by the appliance controller for a very short time in order to fine-tune the negative pressure.

Inert gas (optional)

By applying inert gas to the working chamber, a protective atmosphere can be created which protects the load from contact with ambient air.

Vacuum

The vacuum connection is designed as an ISO-KF connection of size DN 16. Either the supplied pump module or another suitable external vacuum pump are connected to it. When using an external vacuum pump, make sure that the pump is suitable for the material being fed and the desired process.

Required parameters of a suitable pump:

- ▶ Pumping speed > 30 Nl/min
- ▶ Final vacuum ≤ 3 mbar
- ▶ chemical-resistant version
- ▶ temperature resistant (exhaust gas temperature like working temperature)

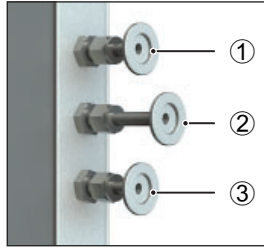

Fig. 4 Connections on the back of VO 49 Premium and VO 101 Premium appliances
 1 Fresh air supply
 2 Inert gas connection
 3 Vacuum pump connection

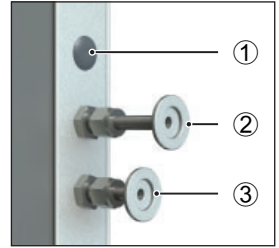

Fig. 5 Connections on the back of VO 29 Premium units and all standard appliances
 1 without function (blanking plug)
 2 Fresh air supply
 3 Vacuum pump connection

2.6.3 Communication interfaces

The communication interfaces are intended for appliances which meet the requirements of IEC 60950-1.

USB interface

The appliance is fitted by default with a USB port in accordance with the USB specification. This way, you can

- ▶ transfer software stored on a USB storage medium to the appliance (see page 60).
- ▶ export protocol logs from the appliance to a USB storage medium (see page 62).
- ▶ transfer user ID data stored on a USB storage medium to the appliance (see page 63).

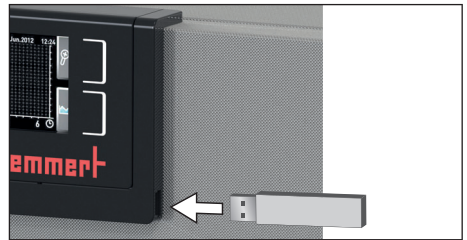

Fig. 6 USB interface

The USB port is located on the right of the ControlCOCKPIT (Fig. 6).

Ethernet interface

The appliance can be connected to a network via the Ethernet interface, so that you can transfer programmes created with the AtmoCONTROL software to the appliance and read out protocols. The Ethernet interface is located on the rear of the appliance (Fig. 7).

For identification purposes, each appliance connected must have its own unique IP address. Configuration of the IP address is described on page 51.

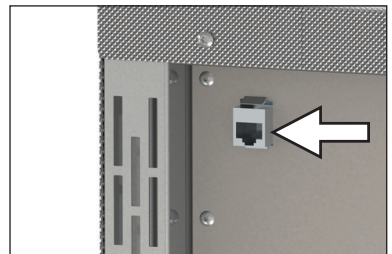

Fig. 7 Ethernet interface



You will find a description of how to transfer programs via Ethernet in the enclosed AtmoCONTROL manual.

The appliance can be directly connected to a computer / laptop using an optional USB to Ethernet converter (see Scope of delivery on page 18).

2.6.4 Switching output for external vacuum pump purge valve and pump control

The 8-pin switching output on the rear right post (Fig. 8) is used to control the vacuum pump of the optional pump module (PM) through the vacuum oven (VO). The switching output is backwards-compatible with the 3-pole contact of older pump modules. For this purpose, plug the 3-pole cable into the 8-pole contact.



Fig. 8 Switching output

Vacuum pump rinsing valve

When drying feed materials with a high moisture content, the pump capacity may decrease during prolonged operation due to condensation in the pump heads. The diaphragms are blown free by briefly flushing the pump heads with fresh air.

This improves the efficiency of the drying process. In combination with the optionally available pump modules PM29, PM49 and PM101, this cyclical flushing takes place automatically when the pump output decreases. The drying process is thus faster and more energy-saving and the pump is protected.

Speed control and switch-off of the vacuum pump

After completing a drying program or after a long period of operation without a vacuum request from the controller, the vacuum pump installed in the pump module (PM) is switched off via the control line. The demand-controlled pump speed control saves energy, is low-noise and increases the service life of the vacuum pump by protecting the pump diaphragms.

Note: A control signal switches off the pump module (PM) installed in the optional vacuum pump. The operating light in the main switch of the pump module also lights up if the vacuum pump has been switched off via the control line.

2.7 Designation (nameplate)

The nameplate (Fig. 9) provides information about the appliance model, manufacturer and technical data. It is attached to the front of the appliance, on the right behind the door.

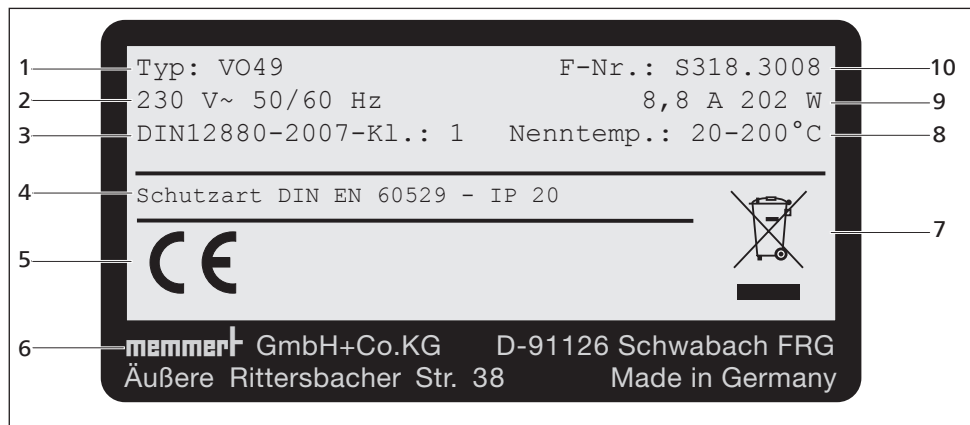

Fig. 9 Nameplate (example)

- | | | | |
|---|---------------------|----|----------------------------|
| 1 | Type designation | 6 | Address of manufacturer |
| 2 | Operating voltage | 7 | Disposal note |
| 3 | Applicable standard | 8 | Temperature range |
| 4 | Protection type | 9 | Connection / power ratings |
| 5 | CE conformity | 10 | Appliance number |

2.8 Technical data

Appliance size		29	49	101
Appliance width D ¹ [mm]		550	550	710
Appliance height E ¹ [mm]		600	680	760
Appliance depth F ¹ [mm]		400	480	550
Depth of door lock [mm]			38	
Chamber width A ¹ [mm]		385	385	545
Chamber height B ¹ [mm]		305	385	465
Chamber depth C ¹ [mm]		250	330	400
Base	Width G [mm]	529	529	689
	Height H [mm]	450	290	130
	Depth I [mm]	383	463	533
Chamber volume [litres]		29	49	101
Weight [kg]		62	74	100
Power [W]		820	2020	2420
Current consumption [A] 230 V, 50/60 Hz		3.6	8.8	10.5
max. number of ther- moshelves	Standard	1	2	2
	Premium	2	4	4
max. load per Thermoshelf [kg]		20		
max. load per appliance [kg]		60	80	150
Temperature	Adjustment range	20 °C to 200 °C		
	Adjustment precision	0.1 K		
	Operating temperature range	5°C above room temperature up to 200°C		
Pressure	Adjustment range	5 mbar - 1100 mbar		
	Adjustment precision	1 mbar		
	Leak rate	≤ 0.5 x 10 ⁻² mbar 1/sec		

¹ See Fig. 10

² The minimum temperature depends on the outdoor temperature (see ambient conditions on page 18).

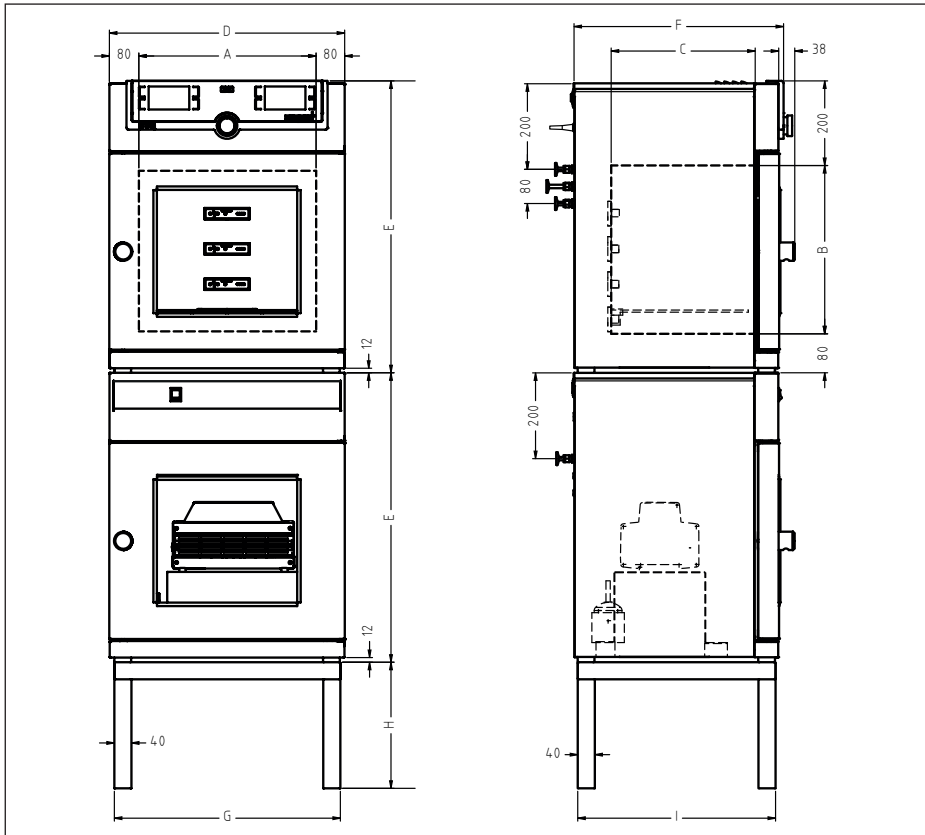

Fig. 10 Dimensions

2.9 Applied directives and standards

Based on the standards and guidelines listed in the following, the products described in this manual have received a CE label from the company Memmert:



- ▶ Directive 2014/30/EC amended (Directive of the European Parliament and of the Council on the approximation of the laws of the Member States relating to electro-magnetic compatibility). Standards complied with:
DIN EN 61326:2004-05, EN 61326:1997, EN 61326/A1:1998, EN 61326/A2:2001
EN 61326/A2:2003
- ▶ Directive 2014/35/EC amended (Directive of the European Parliament and of the Council on the harmonisation of the laws of Member States relating to electrical equipment designed for use within certain voltage limits). Standards complied with:
DIN EN 61 010-1 (VDE 0411 part 1)
DIN EN 61 010-2-010 (VDE 0411 part 2-010)
EN 61 010-1:2001, EN 61 010-2-010

2.10 Declaration of conformity

You can download the EC declaration of conformity of the appliance online:

English: <http://www.memmert.com/en/service/downloads/ce-statement/>

German: <http://www.memmert.com/de/service/downloads/eg-konformitaetserklaerung/>

2.11 Ambient conditions

- ▶ The appliance may only be used in enclosed areas and under the following ambient conditions:

Ambient temperature	+5 °C to +40 °C
Humidity rh	10-80 %rh at 31 °C 50 %rh at 40 °C
Overvoltage category	II
Pollution degree	2
Altitude of installation	max. 2,000 m above sea level
Maximum mains voltage fluctuations	AC 230 V (+/- 10%)

- ▶ The appliance may not be used in areas where there is a risk of explosion. The ambient air must not contain any explosive dusts, gases, vapours or gas-air mixtures. The appliance is not explosion-proof.
- ▶ Heavy dust production or aggressive vapours in the vicinity of the appliance could lead to sedimentation in the interior and, as a consequence, could result in short circuits or damage to electrical parts. For this reason, sufficient measures to prevent large clouds of dust or aggressive vapours from developing should be taken.

2.12 Scope of delivery

- ▶ Power cable
- ▶ Tilt protection
- ▶ Thermoshelves (Standard and Premium VO 29 1 shelf; Premium VO 49 and VO 101 2 shelves)
- ▶ USB storage medium with software and AtmoCONTROL manual
- ▶ the operating instructions at hand
- ▶ Calibration certificate

2.13 Optional accessories

With an Ethernet-USB converter (Fig. 11) it is possible to connect the Ethernet port of the appliance (see page 14) to the USB port of a PC/laptop.

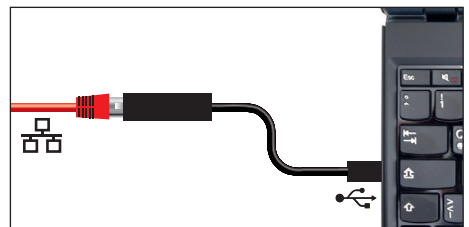

Fig. 11 USB to Ethernet converter

3. Delivery, transport and setting up

⚠ WARNING



The appliance may only be lifted and placed with a special lifting device. This lifting device must be used for lifting and carrying. Without a lifting device there is a great risk of injury!

The lifting device can be purchased from the dealer under the order number B04456 (VO29/49) or B04457 (VO101). Either the dealer sends the device to the customer or the dealer assembles the appliances himself with the device.

To set up appliances of the sizes 29 and 49, at least two persons, for appliances of size 101, four persons are needed.

29	49	101

To lift the appliance, guide the lifting device under the appliance from both sides (Fig. 12) and lift the appliance.



Fig. 12 Lifting equipment

⚠ WARNING



There is a risk of tipping when stacking on a pump module. Do not move stacked device combinations.

3.1 Delivery

The appliance is packed in cardboard and is delivered on a wooden pallette.

3.2 Transport

The appliance can be transported in three ways:

- ▶ With a forklift truck; move the forks of the truck entirely under the pallet.
- ▶ On a manual pallet jack
- ▶ (only with the lifting device)

3.3 Unpacking

i To avoid damage, do not unpack the appliance until you reach the installation site.

Remove the cardboard packaging by pulling it upwards or carefully cutting along an edge.

3.3.1 Checking for completeness and transport damage

- ▶ Check the delivery note to ensure that the scope of delivery is complete.
- ▶ Check the appliance for damage.

If you notice deviations from the delivery note, damage or irregularities, do not put the appliance into operation but inform the haulage company and the manufacturer.

3.3.2 Remove the transportation lock

Remove the transportation lock. It is located between the door hinge, door and frame and has to be removed after opening the door.

3.3.3 Disposing of packaging material

Dispose of the packaging material (cardboard, wood, foil) in accordance with the applicable disposal regulations for the respective material in your country.

3.4 Storage after delivery

If the appliance is first to be stored after delivery: Read the storage conditions from page 65.

3.5 Setting up

⚠ CAUTION



Stacked combinations of appliances can tip over due to their centre of gravity and injure you or someone else. Always attach the appliance to a wall with the tilt protection (see page 23). In case there is not enough space, do not put the appliance into operation and do not open the door. Contact the Memmert service (see page 2).

3.5.1 Preconditions

The installation site must be flat and horizontal and must be able to reliably bear the weight of the appliance (see "Technical data" on page 16). Do not place the appliance on a flammable surface.

A 230 V power connection must be available at the installation site. The maximum mains voltage fluctuation is +/- 10%.

The distance between the wall and the rear of the appliance must be at least 15 cm. The clearance from the ceiling must not be less than 20 cm and the side clearance from walls or nearby appliances must not be less than 5 cm (Fig. 13). Sufficient air circulation in the vicinity of the appliance must be guaranteed at all times.

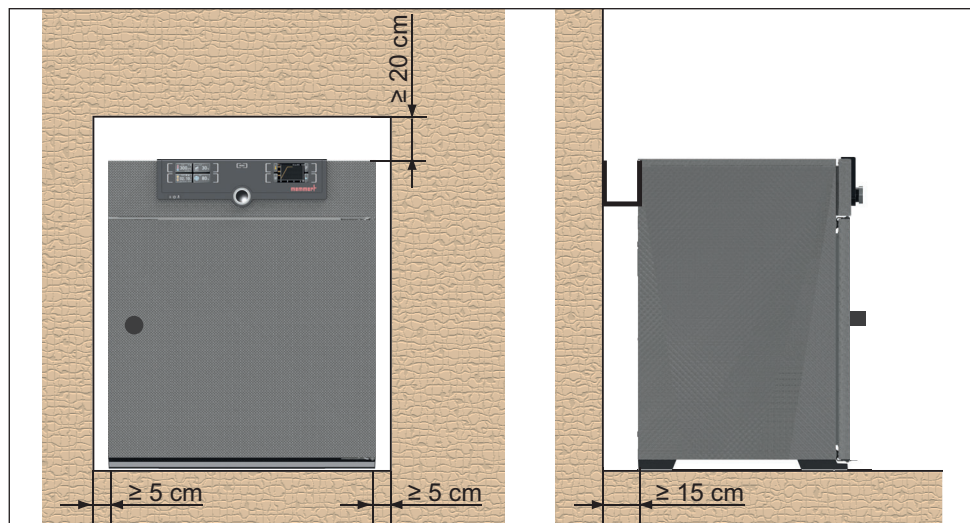





Fig. 13 Minimum clearance from walls and ceiling

3.5.2 Installation options

Setting up	Comments
<p>Bottom</p> 	
<p>Table</p> 	<p>Check the load capacity first</p>
<p>Stacked</p> 	<p>maximum one VO on one pump module; mounting material (feet) is supplied</p>
<p>Sub frame</p> 	<p>Sub frame (without castors)</p>

3.5.3 Tilt protection

Attaching the appliance to a wall using the tilt protection supplied:

1. Install the tilt protection at the two provided positions on the appliance (Fig. 14).
2. Turn the tilt protection upwards by 90° twice (Fig. 15).
3. Drill a hole, insert a dowel and screw the tilt protection to a suitable wall (Fig. 16).



Fig. 14 Install tilt protection on the backside



Fig. 15 Turn the tilt protection upwards

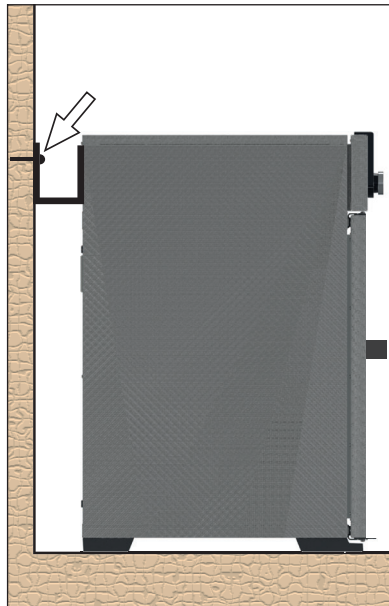

Fig. 16 Screw the tilt protection onto the wall

3.5.4 Adjusting doors

Due to the conditions at the installation site, it may be necessary to adjust the doors.

Adjusting the door in height

1. Open set screw on the front side of the door hinge with Allen key size 2 (Fig. 17).
2. Turn the door bearing (eccentric) clockwise or counter-clockwise with a slotted screwdriver as required (Fig. 18).

Top hinge		Bottom hinge	
Clockwise	down	Clockwise	up
Counter-clockwise	up	Counter-clockwise	down

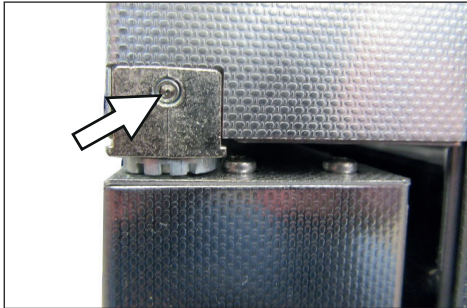

Fig. 17 Set screw

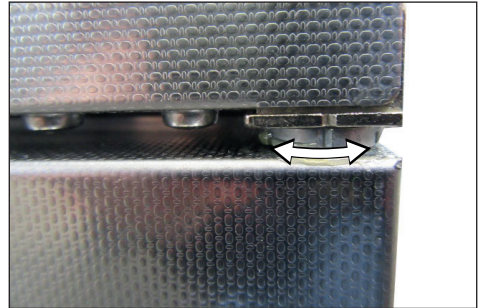

Fig. 18 Turn the collar of the bearing on the slot

3. If the doors are adjusted, clamp the set screw again.

Set distance from door to appliance

NOTICE

- ▶ The distance between door and seal should be chosen so that the door presses against the seal. If the distance between door and seal is too great, the appliance may leak.
1. Loosen the Phillips screw of the locking bolt holder on the lower cross frame with a screwdriver (Fig. 19).
 2. Move the locking piece inwards or outwards.
 3. Fasten the locking piece with the Phillips screwdriver.



Fig. 19 Locking bolt holder

4. Putting into operation

NOTICE

- ▶ When putting the appliance into operation for the first time, do not leave it unattended until it has reached a steady state.

4.1 Connecting the appliance

4.1.1 Connection to the electrical supply

⚠ WARNING



Condensation in the electrical components may cause short circuits. After transporting or storing the device under humid conditions, remove it from its packaging and let it ventilate for at least 24 hours in normal environmental conditions. Do not connect the device to the mains power during this time.

ⓘ Caution:

Observe the country-specific regulations when making connections (e.g. DIN VDE 0100 with earth leakage circuit breaker, in Germany). Observe the connection and power ratings (see nameplate and "Technical data" on page 16). Make sure to establish a safe PE conductor connection.

Place the power cable so that

- ▶ it is easily accessible at all times and can be pulled off quickly, for example in case of interference or an emergency;
- ▶ it does not represent a trip hazard;
- ▶ it cannot come into contact with any hot parts.

Plug the provided power cable into the rear of the appliance and connect it to a CEE 7/4 socket (Fig. 20).

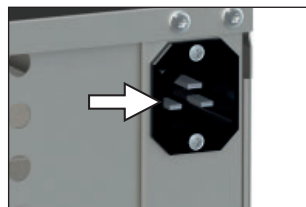

Fig. 20 Network connection

4.1.2 Connecting the pump module or vacuum pump

Use the following for the connection between the device and pump module, the supplied connecting elements and the supplied vacuum hose.

Connect the vacuum connection to the back of the unit (Fig. 21 and Fig. 22 ③) to the vacuum pump connection of the pump module or another suitable vacuum pump using the connecting hose.

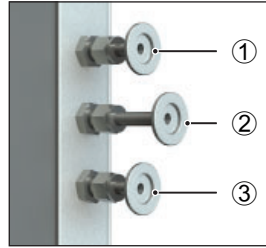

Fig. 21 Connections on the back of VO 49 Premium and VO 101 Premium appliances
 1 Fresh air supply
 2 Inert gas connection
 3 Vacuum pump connection

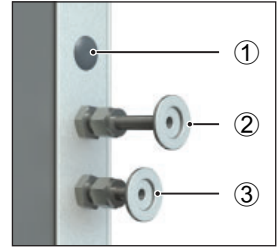

Fig. 22 Connections on the back of VO 29 Premium units and all standard appliances
 1 without function (blanking plug)
 2 Fresh air supply
 3 Vacuum pump connection

NOTICE

When using an external vacuum pump, make sure that it is suitable for the material being fed and the desired process. The pump must meet the following requirements:

- ▶ Pumping speed > 30 NI/min
- ▶ Final vacuum ≤ 3 mbar
- ▶ chemical-resistant version
- ▶ temperature resistant (exhaust gas temperature like working temperature)

4.1.3 Connect inert gas (only with inert gas connection)

⚠ WARNING



Danger of explosion and poisoning when introducing gases/materials other than inert gas. Only inert gas (nitrogen, helium, neon, argon, krypton) may be introduced into the appliance through the gas connection on the rear of the appliance.

⚠ WARNING



Gas bottles may burst or explode at high temperatures. Keep the gas bottles away from open flames. Do not store gas bottles at or above 50 °C and ensure that the location is always well-ventilated. Prevent water from penetrating as well as backflow into the gas bottles. It is essential that you read the safety notes and instructions of the gas supplier.

⚠ CAUTION



When operating with inert gas, the device releases small quantities of the gas used into the environment. Make sure that the room is sufficiently ventilated.

Connect an inert gas cylinder (pressure reducer) with a connecting hose with DN16KF connection to the connection on the rear of the unit (Fig. 21 ②). Set pressure reducer to between 1.0 and 1.2 bar.

4.1.4 Fresh air supply

NOTICE

► Compressed air must not be connected to the fresh air connection.

As a rule, no connecting hose is connected to the fresh air connection. If only clean air may be introduced into the interior, the fresh air connection can be connected by the customer to a tank with treated air.

4.2 Install suction

The type of extraction must comply with the relevant national regulations on occupational safety and environmental protection.

Push a Norprene hose from the outside through the perforated back into the pump stand. Open the door and connect the hose to the outlet (pressure side) of the pump (outlet is hose nipple G1/4 for hose ID9).

4.3 Insert thermoshelves

Thermoshelves can only be operated on levels with a fitted flange socket in the rear panel.

The device is equipped with mechanical locks to secure the thermoshelves. These can be mounted on the support rails of the thermoshelves as required. The locking prevents unintentional loosening of the thermoshelves from the flange socket.

NOTICE

- ▶ When mounting the locking hooks, loosen a fixing screw on the support rail, which may cause the rail to come out of the aligned position. When re-tightening the screw, make sure that the thermoshelf can be inserted smoothly.

Mount the locking hook

1. Remove thermoshelf.
2. Release front screws on left and right, attach locking hooks and tighten slightly.
3. Check if thermoshelf can be inserted smoothly.

Secure thermoshelf

1. Slide the thermoshelf into contact with the rear panel.
2. Turn the locking hook upwards and press it backwards against the thermoshelf (Fig. 23).
3. Fasten Allen screws on both sides using an Allen key size 3.

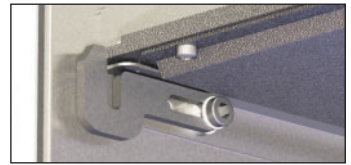

Fig. 23 Thermoshelf locked in place

Remove thermoshelf

1. Loosen Allen screw with Allen key size 3 on both sides.
2. Turn the locking hook downwards (Fig. 24).
3. Pull the thermoshelf out of the flange socket.



Fig. 24 Thermoshelf lock released

4.4 Switching on

1. Switch on suction, if installed.
2. Switch on the pump module or vacuum pump.
3. Switch on the VO by pressing the main switch on the front of the appliance (Fig. 25).

The start-up process is shown by three animated white dots **•••**. If the dots are any other colour, an error has occurred (see page 45).

1 The appliance displays are in English by default when the appliance is switched on for the first time. You can change the language as described from page 50 . However, to get a basic overview of operating the appliance, you should read the following chapter first.

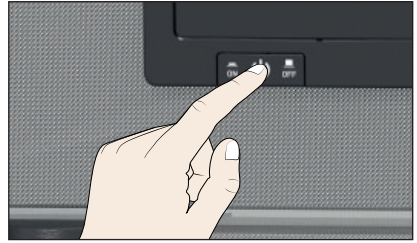

Fig. 25 Switching on the appliance

5. Operation and control

5.1 Operating personnel

The appliance may only be operated by persons who are of legal age and have been instructed accordingly. Personnel who are to be trained, instructed or who are undergoing general training may only work with the appliance under the continuous supervision of an experienced person.

5.2 Opening the door

i The door can only be opened at atmospheric pressure.

- ▶ To open the door, turn handle to the right (Fig. 26).
- ▶ Press door knob in to close (Fig. 27).



Fig. 26 Opening the door
Loading the appliance

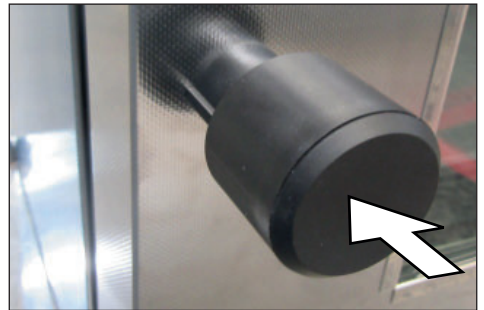

Fig. 27 Closing the door

⚠ WARNING



Toxic gases or vapours may be produced in certain applications. These can escape from the pump module into the room. This can injure people nearby.
The device may only be used for such applications if an extraction system is installed on the pump module which reliably keeps toxic gases or vapours away from people.

NOTICE

- ▶ Check the chamber load for chemical compatibility with the materials of the appliance (see page 12).
- ▶ A vacuum can be built up in the working chamber of the device. Fragile loads can be damaged by the negative pressure. Make sure that you only use material that will not be damaged by negative pressure.

The chamber load is heated in vacuum operation exclusively by direct contact with the inserted thermal shelves. Before starting operation, check whether the thermoshelves are inserted and contacted. If not, insert the required thermoshelves (see also page 28) and check the contact on the temperature display on the ControlCOCKPIT (Fig. 28).

When loading, pay attention to the maximum permissible weight of 20 kg per shelf level.

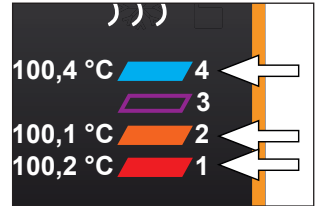

Fig. 28 Thermoshelves in contact

5.3 Operating the appliance

5.3.1 ControlCOCKPIT

In manual mode, the desired parameters are entered in the ControlCOCKPIT on the front of the appliance (Fig. 29). You can also make basic settings here (menu mode). Additionally, warning messages are displayed, e.g. if the temperature is exceeded. In program mode, the parameters defined, the program description, the program segment currently active and program duration remaining are displayed (for a more detailed description, see page 36).

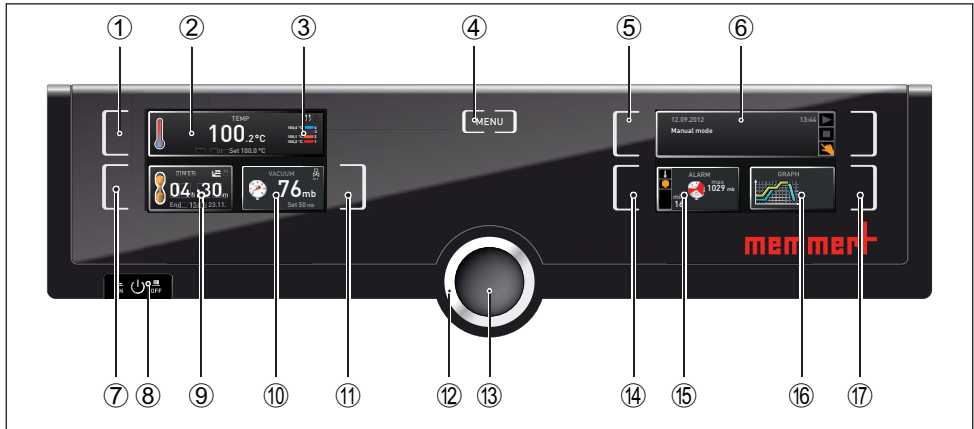

Fig. 29 ControlCOCKPIT in operating mode

- 4 Activation key for temperature setpoint adjustment
- 5 Setpoint and actual temperature display
- 6 Display of actual temperature and contact of the individual thermoshelves
- 7 Switch to menu mode (see page 49)
- 8 Activation key Operating mode
- 9 Status display
- 10 Activation key digital backwards counter with target time setting, adjustable from 1 minute to 99 days
- 11 Main switch
- 12 Display digital backwards counter with target time setting, adjustable from 1 minute to 99 days
- 13 Setpoint and actual pressure display
- 14 Activation button for target pressure setting
- 15 Turn control for setpoint adjustment
- 16 Confirmation key (accepts setting made with the turn control)
- 17 Activation key setting the temperature and pressure monitoring
- 18 Display of temperature and pressure monitoring
- 19 Graphical representation
- 20 Activation key for graphical representation

5.3.2 Basic operation

In general, all settings are made according to the following pattern:

1. Activate the desired parameter (e.g. temperature). To do so, press the corresponding activation key on the left or right or the respective display. The activated display is lined in colour, the other displays are dimmed. The set value is highlighted in colour.

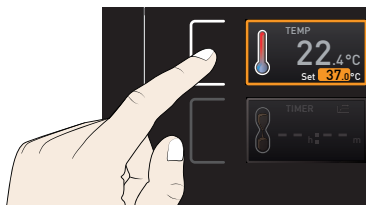

2. By turning the turn control to the left or right, adjust the set value (e.g. to 180.0 °C).

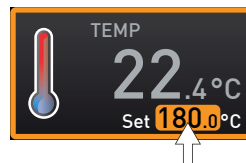

3. Save the set value by pressing the confirmation key. The display returns to normal and the appliance begins adjusting to the defined set value.

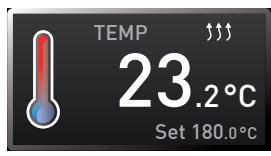
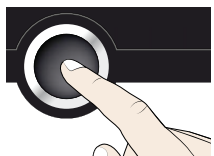

The settings for further parameters and functions (pressure) can be made accordingly.

- 1 If no new values are entered or confirmed for approx. 30 seconds, the appliance automatically restores the former values.

If you want to abort the setting procedure, press the activation key on the left or right of the display that you want to exit. The appliance restores the former values. Only the settings that you have confirmed by pressing the confirmation key before cancelling the setting procedure are accepted.

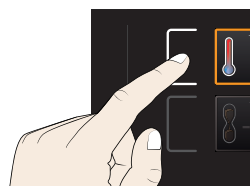

5.3.3 Operating modes

The appliance can be operated in different modes:

- ▶ Manual mode: The appliance runs in permanent operation at the values set on the ControlCOCKPIT. Operation in this mode is described in chapter 5.3.4.
- ▶ Operation with digital backwards counter with target time setting, adjustable from 1 minute to 99 days (timer): The appliance will run at the values set until the set time has elapsed. Operation in this mode is described in chapter .
- ▶ program mode: The appliance automatically runs program sequences which have been defined using AtmoCONTROL software at a computer / laptop and then transferred to the appliance from a USB stick or via Ethernet. Operation in this mode is described in chapter 5.3.6.
- ▶ By remote control

The status display shows which operating mode or operating state the appliance is currently in. The current operating state is highlighted in colour and indicated by the text display:

- ▶ Appliance is in program mode
- program is stopped
- 👉 Appliance is in manual mode

The example on the right shows the appliance in manual mode, identified by the coloured hand symbol.

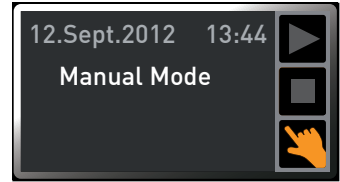

- ▶ When the appliance is in timer mode, **Timer active** is displayed:
- ▶ If the appliance is in remote control mode, the symbol appears in the temperature display:

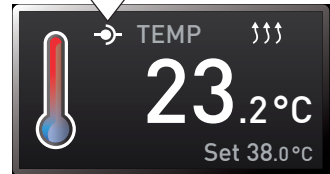
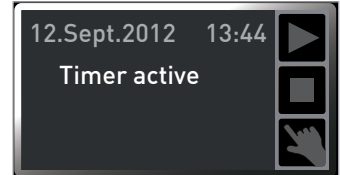

5.3.4 Manual mode

In this operating mode, the appliance runs in permanent operation at the values set on the ControlCOCKPIT.

Adjustment options

As described in chapter 5.3.2, you can set the following parameters after pressing the corresponding activation key (in any sequence):

Temperature

adjustment range: 20 °C to 200 °C

The display on the right shows the temperatures of the individual thermoshelves and whether they are in contact. Thermoshelf 3 is not in contact in the example on the right.



● Heating operation is indicated by the symbol.

I You can select °C or °F as the temperature units displayed (see page 52).

Pressure

Setting range 5 to 1100 mbar

● The display In1/In2 top right (arrow, only for Premium **I** VO49 and 101) indicates which gas connection is currently active:

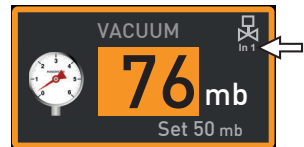

- ▶ In1 is displayed when fresh air is open.
- ▶ In2 is displayed when inert gas is open.
- ▶ No icon is displayed if no contact is open.

Which gas connection should be active can be set in menu mode (see page 52).

If a pressure range is set above 1100 mb, the message open appears. The old actual value is retained when the confirmation key is pressed. This function is intended for extracting chamber load material, i.e. for generating atmospheric pressure.

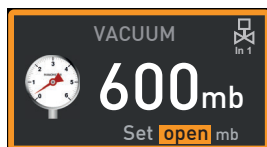

If a pressure range is set below 5 mb, the message low appears. The old actual value is retained when the confirmation key is pressed. In Low operation, the vacuum pump operates at maximum and there is no pressure control. The achieved pressure depends only on the ultimate attainable vacuum of the pump.

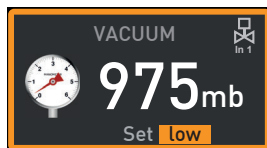

5.3.5 Operation with digital backwards counter with target time setting, adjustable from 1 minute to 99 days (timer)

In timer operation, you can adjust the time the appliance runs at the set values. The appliance has to be in manual operating mode for this.

1. Press the activation key to the left of the timer display. The timer display is activated.

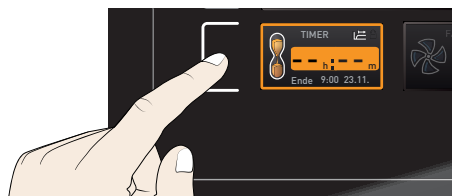

2. Turn the turn control until the desired duration is displayed – in this example 4 hours 30 minutes. The approximate end time is shown beneath, in a smaller font.



- Up to a duration of 23 hours 59 minutes, the time is displayed in hh:mm (hours:minutes) format. For 24 hours and more, the format dd:hh (days:hours) is used. The maximum duration adjustable is 99 days 00 hours.

3. Press the confirmation key to confirm.

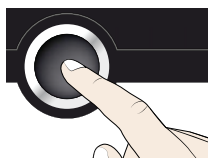

The display now shows the remaining time in a large font and the approximate end time in a smaller font beneath. The status display shows Timer active.



4. Now, as described in chapter 5.3.2, set the values for temperature and pressure, which you want the appliance to operate at. The set values can be changed at any time while the timer elapses. The changes are effective immediately.

1 In **Setup**, you can choose if the timer should be setpoint-dependent or not. This determines whether the timer should not start until a tolerance band around the set temperature is reached or if it should start immediately after activation (see page 53). The symbol on the timer display indicates that the timer is set to setpoint-dependent.

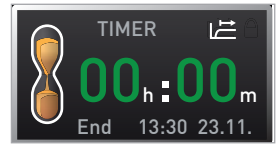

Once the timer has finished, the display shows 00h:00m. All functions (heating etc.) are switched off. If a fan was on, it will continue running for a short safety period. In addition, an acoustic alarm sounds, which can be turned off by pressing the confirmation key.

To deactivate the timer, open the timer display by pressing the activation key again and then turning the turn control to reduce the timer setting until --:-- is displayed. Press the confirmation key to confirm.

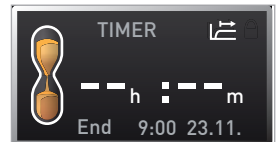

5.3.6 Program mode

In this operating mode, programs saved in the appliance can be started with different combinations of individual parameters (temperature, Pressure) at staggered intervals, which the appliance then automatically processes in sequence. These programs are not created directly at the appliance but externally at a computer / laptop and using AtmoCONTROL software. Transfer to the appliance is possible using the provided USB storage medium or via Ethernet.



A description of how to create and save programs can be found in the separate AtmoCONTROL software manual.

Starting a program

1. Press the activation key on the right of the status display. The current operating mode is highlighted automatically, in this example Manual mode ().

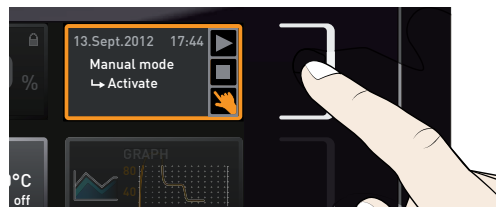

2. Turn the turn control until the start symbol is highlighted. The current program is displayed, in this example Test 012.

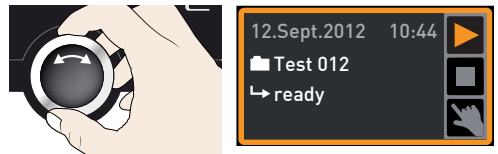

1 Only the program currently selected in menu mode and shown in the display can be used. If you want to process another program, you need to activate it in menu mode first (see description starting on page 60).

3. To start the program, press the confirmation key. The program is activated. The display shows:

- ▶ the program description (in this example Test 012)
- ▶ the program segment description, in this example Ramp 1
- ▶ the current run (in case of loops)

1 You cannot change any parameters (e.g. the temperature) at the appliance while a program is running. However, the displays ALARM and GRAPH can still be used.

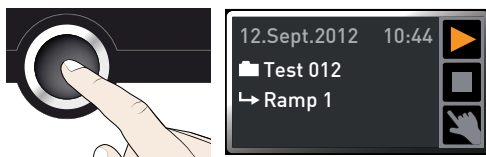

Cancel program

You can cancel an active program at any time.

1. Press the activation key to the right of the status display. The status display is automatically highlighted.



2. Turn the turn control until the ■ stop symbol is highlighted.

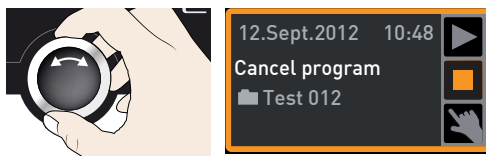

3. Press the confirmation key to confirm. The program is cancelled.

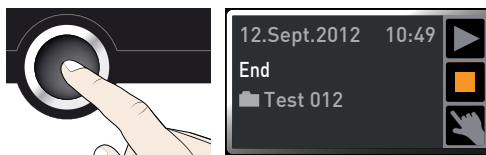

1 A cancelled program cannot be resumed at the point it was cancelled. It must be restarted from the beginning.

End of program

End is shown on the display to indicate that the program has finished.

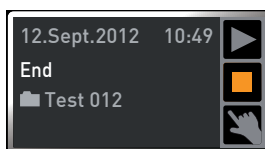

You can now

- ▶ restart the program as described
- ▶ select another program to run in menu mode (see page 60) and run it as described.
- ▶ Return to manual mode. To do so, reactivate it by pressing the activation key next to the status display, then turn the turn control until the hand symbol is highlighted in colour and press the confirmation key.

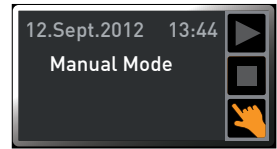

5.4 Temperature monitoring

The appliance is equipped with multiple overtemperature protection (mechanical/electronic) in accordance with DIN 12 880. This serves to avoid damage to the chamber load and/or appliance in case of a malfunction:

- ▶ electronic temperature monitoring (TWW)
- ▶ automatic temperature monitor (ASF)
- ▶ mechanical temperature limiter (TB)

The monitoring temperature of the electronic temperature monitoring is measured via a separate Pt100 temperature sensor in the interior. Temperature monitoring settings are made via the **ALARM** display. The settings made apply to all operating modes.

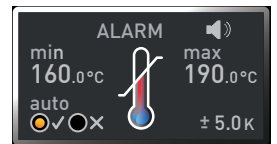

If temperature monitoring has been triggered, this is indicated on the temperature display: the actual temperature is highlighted in red and a warning symbol is shown (Fig. 30). The type of temperature monitoring triggered (TWW in this example) is shown beneath the temperature.

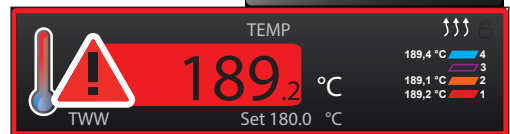

Fig. 30
Temperature monitoring triggered

If the acoustic alarm has been activated in menu mode (**Sound** see page 61, indicated by the speaker symbol on the alarm display), the alarm is additionally signalled by an intermittent acoustic signal, which can be turned off by pressing the confirmation key. Information on what to do if this happens can be found in chapter Malfunctions, warning and error messages from page 45.

Before reading how to adjust temperature monitoring (from page 40), please read the description of the individual monitoring functions here.

5.4.1 Electronic temperature monitoring (TWW)

The manually set monitoring temperature **min.** and **max.** of the electronic overtemperature control is monitored by an adjustable over/undertemperature controller (TWW) protection class 3.1 acc. to DIN 12 880 (or over/undertemperature controller (TWW) protection class 3.1 for UIS appliances). If the manually set monitoring temperature **max** is exceeded, the TWW takes overtemperature control and begins to regulate the monitoring temperature (Fig. 31).

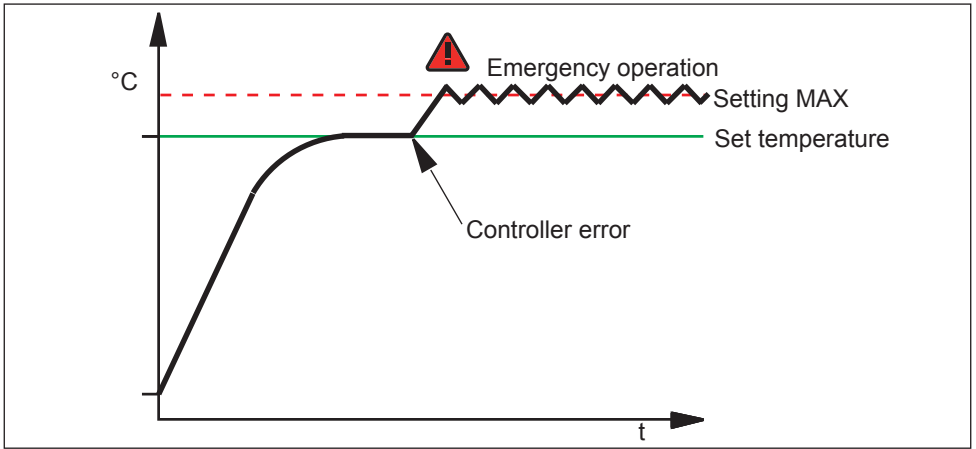

Fig. 31 Schematic diagram of how TWW temperature monitoring works

5.4.2 Automatic temperature monitor (ASF)

ASF is a monitoring device that automatically follows the set temperature setpoint within an adjustable tolerance band (Fig. 32).

The ASF – if switched on – is automatically activated as soon as the actual temperature value reaches 50 % of the set tolerance band of the setpoint (in the example: 180 °C - 1.5 K) for the first time (section A).

When the temperature violates the set tolerance band around the setpoint (in the example in Fig. 32:

180 °C ± 3 K) – e.g. if the door is opened during operation (section B of illustration) – the alarm is set off. The ASF alarm is automatically terminated as soon as 50 % of the set tolerance band of the setpoint (in the example: 180 °C ± 1.5 K) are reached again (section C).

If the temperature setpoint is altered, the ASF is automatically disabled temporarily (in this example: The setpoint is changed from 180 °C to 173 °C, section D), until it reaches the tolerance range of the new temperature setpoint (section E).

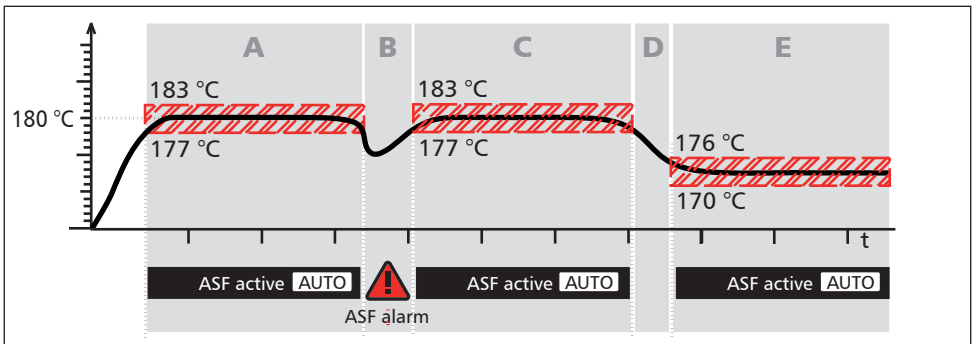

Fig. 32 Schematic diagram of how the ASF temperature monitoring works

5.4.3 Mechanical temperature monitoring: Temperature limiter (TB)

The appliance is equipped with a mechanical temperature limiter (TB) of protection class 1 in accordance with DIN 12 880.

If the electronic monitoring unit should fail during operation and the factory-set maximum temperature is exceeded by approx. 20 °C, the temperature limiter, as the final protective measure, switches off the heating permanently.

5.4.4 Adjusting temperature monitoring

1. Press the activation key to the left of the ALARM display. The temperature setting is automatically highlighted.



2. Accept the selection by pressing the confirmation key. The min setting (undertemperature protection) is automatically activated.

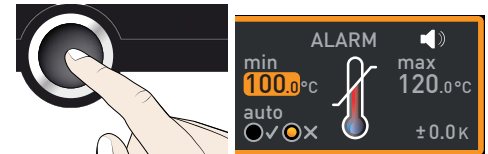

3. By turning the turn control, adjust the desired lower alarm limit value, in the example on the right 160 °C.

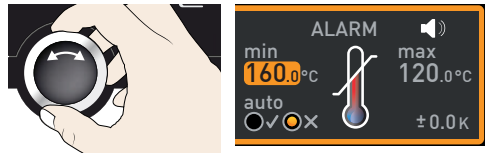

- i** If no undertemperature protection limit is required, set the lowest temperature.

4. Press the confirmation key to confirm. The max display (overtemperature protection) is activated.

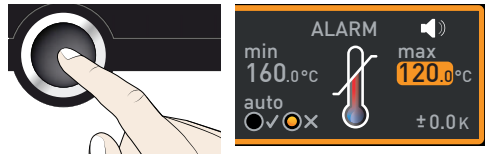

5. By turning the turn control, adjust the desired upper alarm limit value, in the example on the right 190 °C.

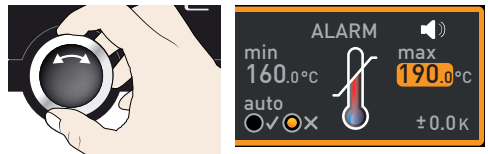

- i** The monitoring temperature must be set sufficiently high above the maximum set temperature. We recommend 5 to 10 K.

6. Accept the upper alarm limit value by pressing the confirmation key. The setting of the automatic temperature monitor (ASF) is automatically activated (auto).

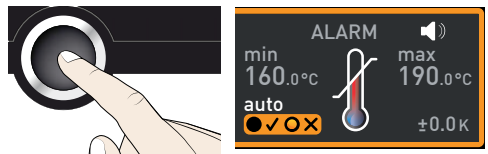

- With the turn control, select ON (✓) or OFF (✗).

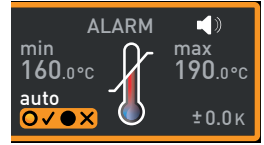

- Press the confirmation key to confirm. The ASF tolerance band setting is activated.

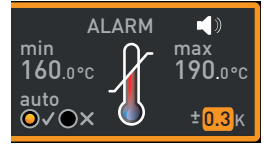
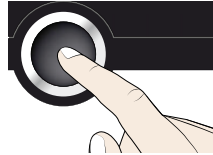

- With the turn control, adjust the desired tolerance band, e.g. 5.0 K.

i We recommend a tolerance band of 5 to 10 K.

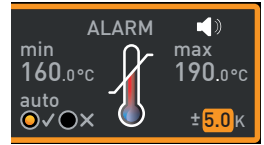

- Press the confirmation key to confirm. Temperature monitoring is now active.

i In menu mode you can set, whether an acoustic signal should be triggered in the event of an alarm (see page 61))

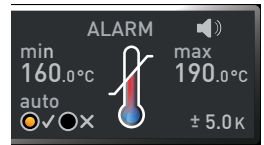
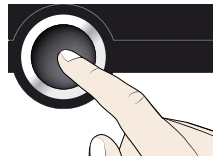

5.5 Pressure monitoring

If the pressure monitoring was triggered, this is indicated by the pressure display: by the actual pressure highlighted in red and an alarm symbol is shown (Fig. 33). If the acoustic alarm has been activated in menu mode (Sound, see page 60, as indicated by the speaker symbol) , the alarm is additionally signalled by an intermittent acoustic signal. Information on what to do if this happens can be found in chapter Malfunctions, warning and error messages from page 45.

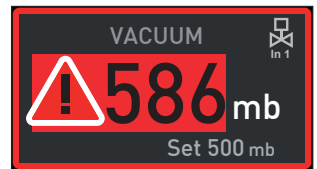
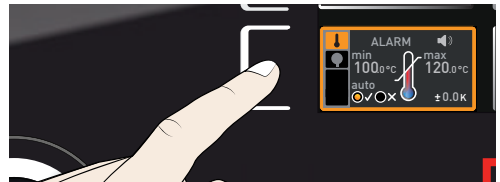

Fig. 33
Pressure monitoring triggered

Setting the pressure monitoring

- Press the activation key to the left of the ALARM display. The temperature monitoring setting is automatically activated.



- Turn the turn control until the pressure monitoring entry is highlighted.

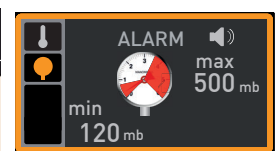

3. Accept the selection by pressing the confirmation key. The lower alarm limit is automatically selected.

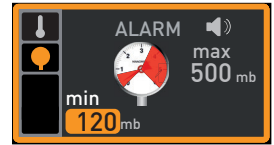
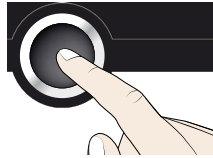

4. By turning the turn control, adjust the desired lower alarm limit, in the example on the right 30 mbar.

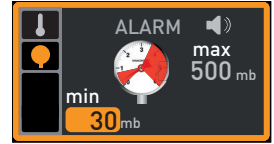

5. Accept the selection by pressing the confirmation key. The upper alarm limit is automatically highlighted.

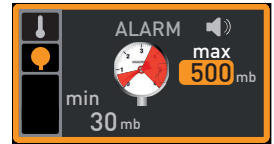
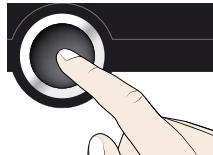

6. By turning the turn control, adjust the desired upper alarm limit, in the example on the right 600 mbar.

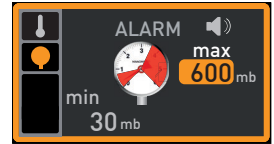

7. Accept the selection by pressing the confirmation key and leave the Alarm display by pressing the activation key on the side. Pressure monitoring is now active and triggers as soon as the value falls below 30 mbar or exceeds 600 mbar.

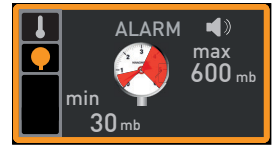
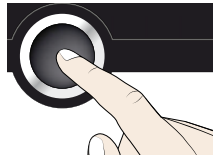

5.6 Graph

The GRAPH display provides an overview of the chronological sequence of the setpoint values and actual values for temperature and pressure content as a curve.

5.6.1 Temperature profile

1. Press the activation key to the right of the GRAPH display. The display is enlarged and the temperature curve of the individual thermoshelves is displayed. The colours correspond to those of the thermoshelf symbols in the temperature display. The red curve shows, for example, the temperature curve of thermoshelf 1.

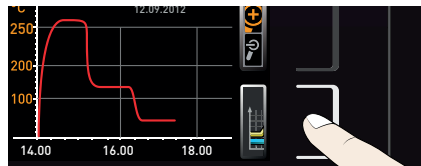

- ▶ To change the time frame to be displayed: Press the activation key next to the $\langle \rangle$ arrow symbols. The time frame to be displayed can now be changed by turning the turn control.

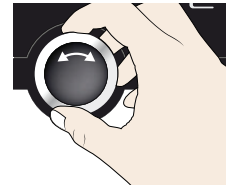
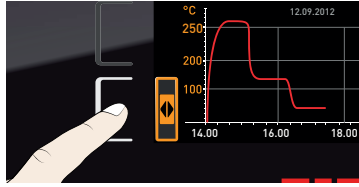

- ▶ To zoom the graph in or out: Press the activation key next to the magnifying glass symbol. With the turn control, select if you want to zoom in or out (+/-) and confirm your selection by pressing the confirmation key.

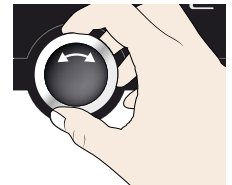
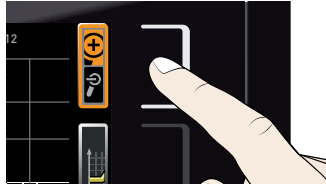

To close the graphical representation, press the activation key you used to activate it again.

5.6.2 Pressure pattern

1. Activate graphic representation as described above and then press the activation key next to the parameter selection.

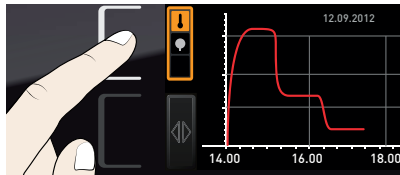

2. Set the pressure with the turn control .

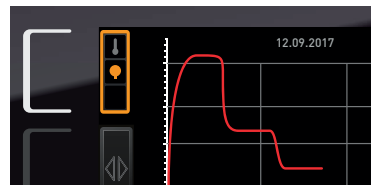
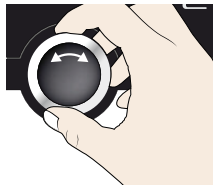

3. Press the confirmation key to confirm. The pressure curve is now displayed in green. You can change the display range as described above, as well as extend or reduce it.

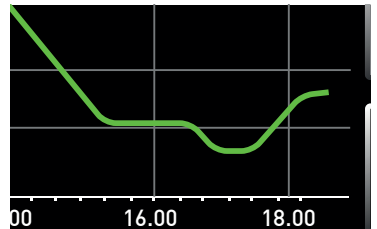
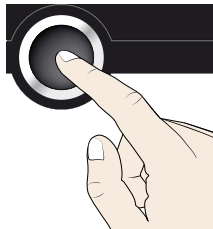

5.7 Ending operation

⚠ WARNING



Depending on operation, the surfaces in the working chamber and the chamber load may still be very hot after the appliance is switched off. Touching these surfaces can cause burns. Wear heat-resistant protective gloves or wait until the appliance cools down before touching.



- Switch off active appliance functions (turn back the set values). Switch off the pump module or vacuum pump.
- Remove the chamber load (door cannot be opened until atmospheric pressure is reached inside the unit).
- Switch off the VO with the main switch (Fig. 34).

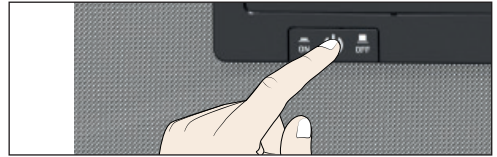

Fig. 34 switch off VO

6. Malfunctions, warning and error messages

⚠ WARNING



After removing covers, live parts may be exposed. Touching these can lead to an electric shock. Malfunctions requiring work inside the appliance may only be rectified by electricians. Observe the separate service manual for this.

Do not try to rectify appliance errors yourself but contact the MEMMERT customer service department (see page 2) or an authorised service point.

In case of enquiries, please always specify the model and appliance number given on the nameplate (see page 15).



6.1 Warning messages of the monitoring function

i If the acoustic alarm has been activated in the menu mode (Sound, see page 61, indicated by the speaker symbol  in the alarm display), the alarm is additionally signalled by an intermittent acoustic signal. If the confirmation key is pressed, the acoustic alarm can be temporarily switched off until the next alarm event occurs.

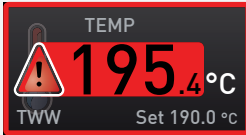
6.1.1 Temperature monitoring



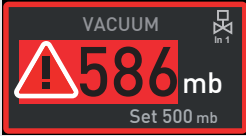







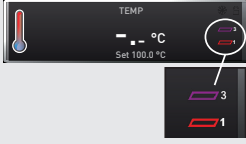

Description	Cause	Action	See
Temperature alarm and "ASF" are displayed 	Automatic temperature monitor (ASF) was triggered.	Check if the door is closed. Close the door. Extend the ASF tolerance band If the alarm continues: Contact customer service	Page 39 Page 2
Temperature alarm and "TWW" are displayed 	The adjustable temperature controller (TWW) has assumed heating control.	Increase the difference between the monitoring and setpoint temperature – by either increasing the max value of the temperature monitoring or decreasing the setpoint temperature. If the alarm continues: Contact customer service	Page 40 Page 2
Temperature alarm and "TB" are displayed 	The mechanical temperature limiter (TB) permanently switched off heating.	Switch off the appliance and leave to cool down. Contact customer service and have the error rectified (e.g. by replacing the temperature sensor).	Page 2

6.1.2 Pressure monitoring

Description	Cause	Action	See
Pressure alarm and MaxAL are displayed 	Upper pressure limit value exceeded	Vacuum pump has too little power. Tube may be leaking or kinked, clean, check	
Pressure alarm and MinAL are displayed 	Pressure below lower limit	Speed control damaged or intake valve does not close correctly. Notify customer service.	Page 2

6.2 Malfunctions, operating problems and appliance errors

Error description	Cause of errors	Rectifying errors	See
Displays are dark	External power supply was interrupted	Check the power supply	Page 25
	Miniature fuse, appliance fuse or power module faulty	Contact customer service	Page 2
Displays cannot be activated	Appliance locked by USER ID	Unlock with USER ID	Page 63
	The appliance is in program, timer or remote control mode (mode "Write" or "Write + Alarm")	Wait until the end of the program or timer mode or switch off the remote control	
Displays suddenly look different	Appliance is in "wrong" mode	Change to operating or menu mode by pressing the MENU key	
Door cannot be opened	Vacuum in the appliance	Setting the atmospheric pressure	

Error description	Cause of errors	Rectifying errors	See
	<ul style="list-style-type: none"> ▶ Thermoshelf not detected ▶ Temperature sensor in thermoshelf defective 	<ul style="list-style-type: none"> ▶ Check for correct positioning of the thermoshelf ▶ Clean contacts on the device and on the thermoshelf ▶ Contact customer service 	Page 2
Error message E-7 in the pressure display 	Pressure sensor defective. No pressure control possible.	<ul style="list-style-type: none"> ▶ Contact customer service 	Page 2
When switching on the appliance, the start animation is displayed in another colour than white 	<ul style="list-style-type: none"> ▶ Cyan   : Not enough storage space on the SD card ▶ Red   : The system files could not be loaded ▶ Orange   : The fonts and images could not be loaded 	Contact customer service Contact customer service Contact customer service	Page 2 Page 2 Page 2

6.3 Power failure

In case of a power failure, the appliance operates as follows:

In manual mode

After power supply has been restored, operation is continued with the parameters set. The time and duration of the power failure are documented in the log memory.

In timer or program mode

In case of an interruption of the power supply of less than 60 minutes, the current programme is continued from the point at which it was interrupted. For interruptions of the power supply longer than this, all appliance functions (heating, fan etc.) are switched off and the air flap is opened.

In remote control mode

The previous values are restored. If a program has been initiated via remote control, it is continued.

NOTICE

Please refer to the operating manual for the vacuum pump used in the event of a power failure. It may need to be turned back on.

7. Menu mode

In menu mode, you can make basic settings, load programs and export protocols, as well as adjust appliance parameters.

NOTICE

Before changing menu settings, read the description of the respective functions on the following pages to avoid possible damage to the appliance and/or chamber load.

To enter menu mode, press the MENU key.

- 1 To exit the menu mode at any time, press the MENU key again. The appliance then returns to operating mode. Only changes accepted by pressing the confirmation key are saved.

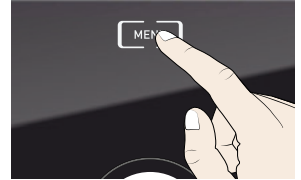

7.1 Overview

Press the MENU key to change between the displays in menu mode:

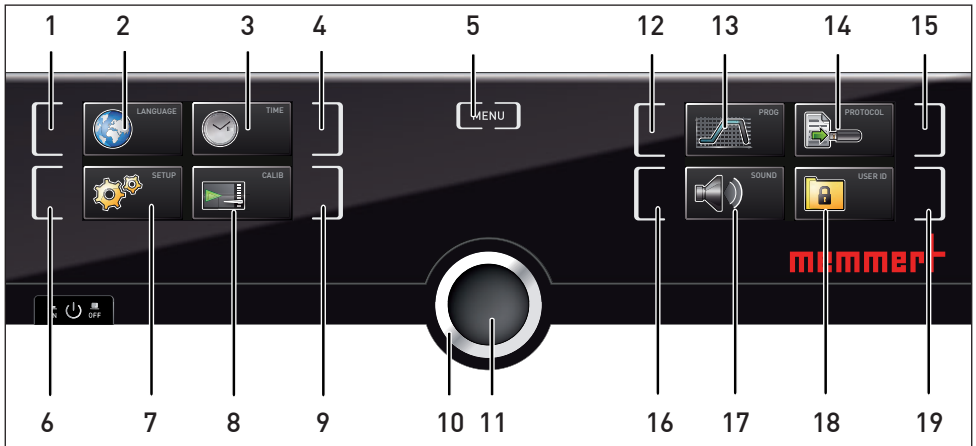

Fig. 35 ControlCOCKPIT in menu mode

- | | |
|---|--|
| <ul style="list-style-type: none"> 1 Language selection activation key 2 Language selection display 3 Date and time display 4 Date and time setting activation key 5 Exit menu mode and return to operating mode 6 Setup activation key (basic appliance settings) 7 Setup display (basic appliance settings) 8 Adjustment display 9 Adjustment activation key | <ul style="list-style-type: none"> 10 Turn control for adjustment 11 Confirmation key (accepts setting made with the turn control) 12 program selection activation key 13 program selection display 14 Protocol display 15 Protocol activation key 16 Acoustic signal adjustment activation key 17 Acoustic signal adjustment display 18 USER ID display 19 USER ID activation key |
|---|--|

7.2 Basic operation in menu mode using the example of language selection

In general, all settings in menu mode are done just like in operating mode: Activate the respective display, use the turn control for setting and press the confirmation key to accept the change. A more detailed description is provided in the following, using the example of language selection.

1. Activate the desired parameter (in this example the language). To do so, press the corresponding activation key on the left or right of the respective display. The activated display is enlarged.

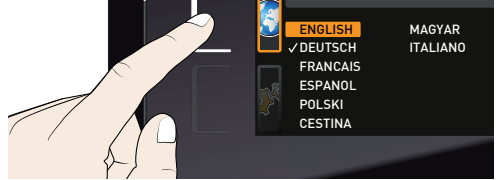

- i** If you want to exit or cancel the settings, again press the activation key which you have used to activate the display. The appliance returns to the menu overview. Only the settings that you have confirmed by pressing the confirmation key before cancelling the setting procedure are accepted.



2. Select the desired new setting, e.g. Spanish (ESPAÑOL) using the turn control.

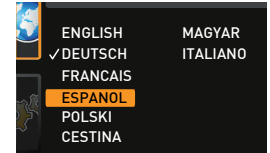

3. Save the setting by pressing the confirmation key.

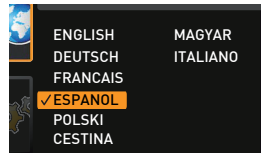
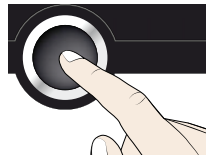

4. To return to the menu overview, press the activation key again.



You can now

- ▶ activate another menu function by pressing the corresponding activation key or
- ▶ return to operating mode by pressing the MENU key.



All other settings can be made accordingly. The settings possible are described in the following sections.

i If no new values are entered or confirmed for approx. 30 seconds, the appliance automatically restores the former values.

7.3 Setup

7.3.1 Overview

In the SETUP display, you can set the following parameters:

- ▶ the IP address and subnet mask of the appliance's Ethernet interface (for connection to a network)
- ▶ The units of the temperature display (°C or °F, see page 52)
- ▶ of the gas connection that should be active (1 or 2, only for appliances VO 49 Premium and VO 101 Premium)
- ▶ How the digital backwards counter with target time setting works (Timer mode, see page 53)
- ▶ Remote control (see page 53)
- ▶ Gateway (see page 54)

i If the Setup menu contains more entries than can be displayed, this is indicated by the display "1/2". This means that there is a second "page" of entries.

To display the hidden entries, use the turn control to scroll beyond the lowest entry. The page display changes to "2/2".

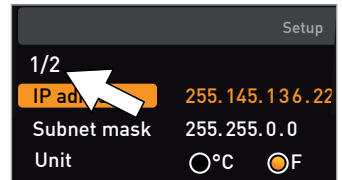

7.3.2 IP address and subnet mask

If you want to operate one or more appliances in a network, each appliance must have its own unique IP address for identification. By default, each appliance is delivered with the IP address 192.168.100.100.

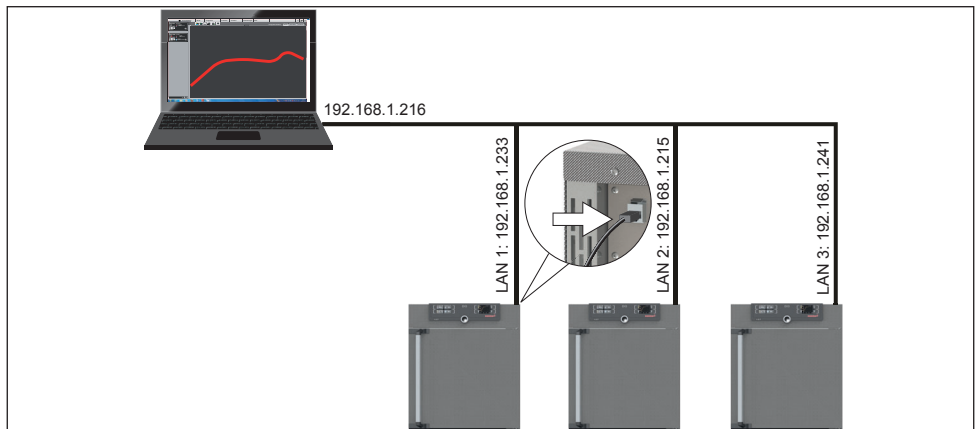
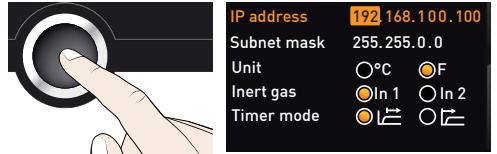

Fig. 36 Operation of several appliances in a network (schematic example)

1. Activate the SETUP display. The entry IP address is automatically high-lighted.



2. Accept the selection by pressing the confirmation key. The first three digits of the IP address are automatically selected.



3. With the turn control, set the new number, e.g. 255.

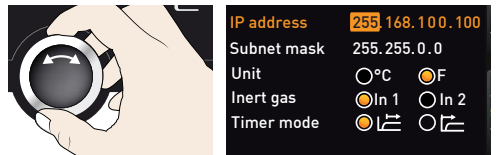

4. Accept the selection by pressing the confirmation key. The next three digits of the IP address are automatically selected. Setting these is done according to the description above.

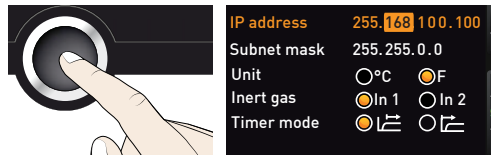

5. After setting the last three digits, accept the new IP address by pressing the confirmation key. The selection returns to the overview. The subnet mask is set accordingly.

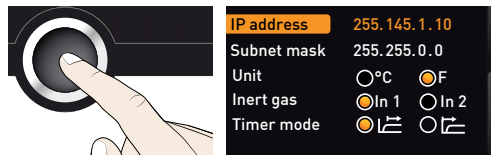

7.3.3 Unit

Here, you can choose whether the temperature is displayed in °C or °F.

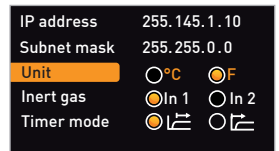

7.3.4 Gas inlet

(only for devices VO 49 Premium and VO 101 Premium)

Here you can set which of the two gas connections(see page 13) should be active.

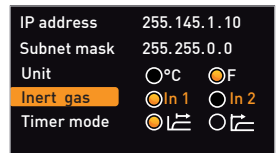

7.3.5 Timer mode

Here, you can choose whether the digital backwards counter with target time setting (see page 35, timer) should be setpoint-dependent or not – this determines whether the timer should not start until a tolerance band of ± 3 K around the set temperature is reached (Fig. 37, B) or whether it should start immediately after activation (A).

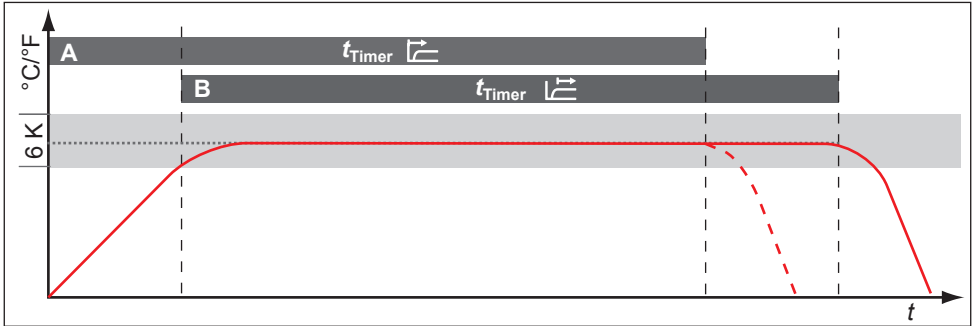
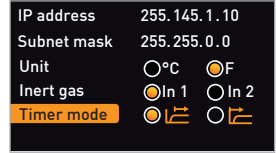

Fig. 37 Timer mode

- A Timer independent of setpoint: Timer starts immediately after activation
- B Timer setpoint-dependent: Timer does not start until tolerance band is reached

1 If the temperature tolerance band is exceeded in setpoint-dependent mode, the timer will be interrupted and only be resumed when the setpoint temperature is reached again.

7.3.6 Remote control

In the setup entry remote control, you can set whether the appliance should be controlled via remote control and if so, in which mode. These settings are available:

- ▶ Off
- ▶ Read-only
- ▶ Write + Read
- ▶ Write + Alarm

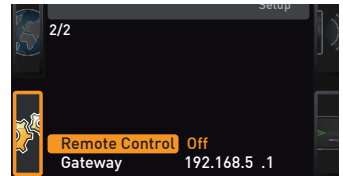

If the appliance is in remot control mode, the symbol  appears in the temperature display. In the settings Write + Read and Write + Alarm, the appliance cannot be controlled at the ControlCOCKPIT until the remote control has been switched off (setting Off) or set to Read only.

1 In order to use the remote control function, programming skills and special libraries are required.

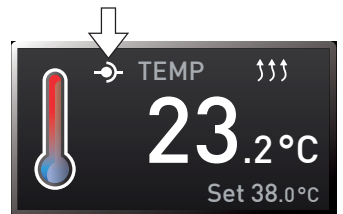

7.3.7 Gateway

The setup entry gateway is used to connect two networks with different protocols.

The gateway is set the same way as the IP address (see page 51).

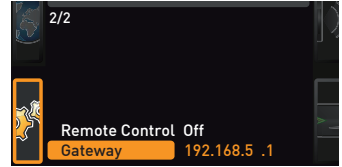

7.4 Date and time

In the TIME display, you can set the date and time, time zone and daylight saving time. Changes can only be made in manual operating mode.

1 Always set the time zone (and daylight saving time yes/no) before setting the date and time. Avoid changing the set time after that since this can lead to gaps or overlapping when recording measured values. If you still need to change the time, you should not run a program immediately before or after doing so.

1. Activate the time setting. To do so, press the activation key on the right side of the TIME display. The display is enlarged and the first adjustment option (Date) automatically highlighted.



2. Turn the turn control until Time zone is highlighted.

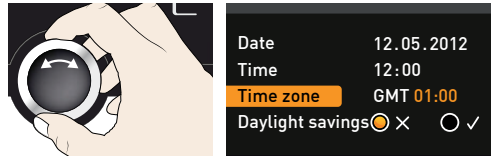

3. Accept the selection by pressing the confirmation key.

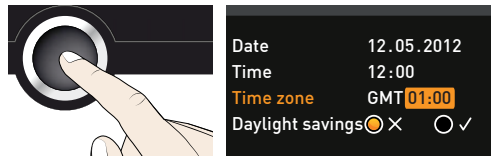

4. Set the time zone of the installation site with the turn control, e.g. 00:00 for the UK, and 01:00 for France, Spain or Germany. Accept the selection by pressing the confirmation key.

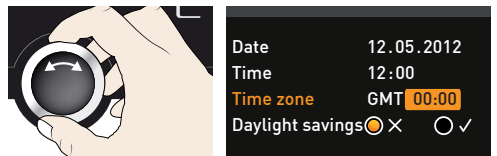

5. With the turn control, select the Daylight savings entry.

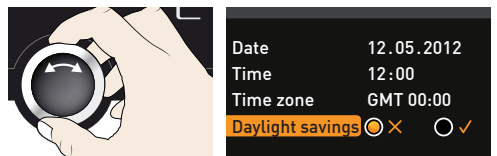

6. Accept the selection by pressing the confirmation key. The adjustment options are highlighted.

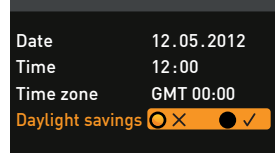
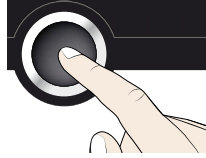

7. Set daylight savings to off (X) or on (✓) with the turn control – in this case on (✓). Save the setting by pressing the confirmation key.

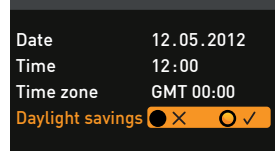

i Daylight saving time and standard time are not changed automatically. For this reason, please keep in mind to adjust them at the beginning of each period.

8. Now, set date (day, month year) and time (hours, minutes) in the same way. Accept the selection by pressing the confirmation key.

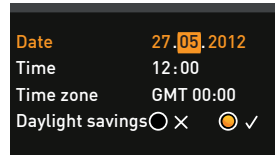

7.5 Calibration

The appliances are calibrated and adjusted at the factory. In case readjustment should be necessary later on – for example due to influence of the chamber load – temperature and pressure can be adjusted according to customer requirements with three individually selected adjustment points:

- ▶ Cal1Adjustment at low value
- ▶ Cal1Adjustment at middle value
- ▶ Cal1Adjustment at high value

To guarantee perfect control, we recommend to calibrate the appliance once a year.

7.5.1 Temperature calibration

i For temperature adjustment, you will need a calibrated reference measuring device.

i Each thermoshelf can be calibrated individually. This is only possible with the AtmoCONTROL software (see AtmoCONTROL manual for description).

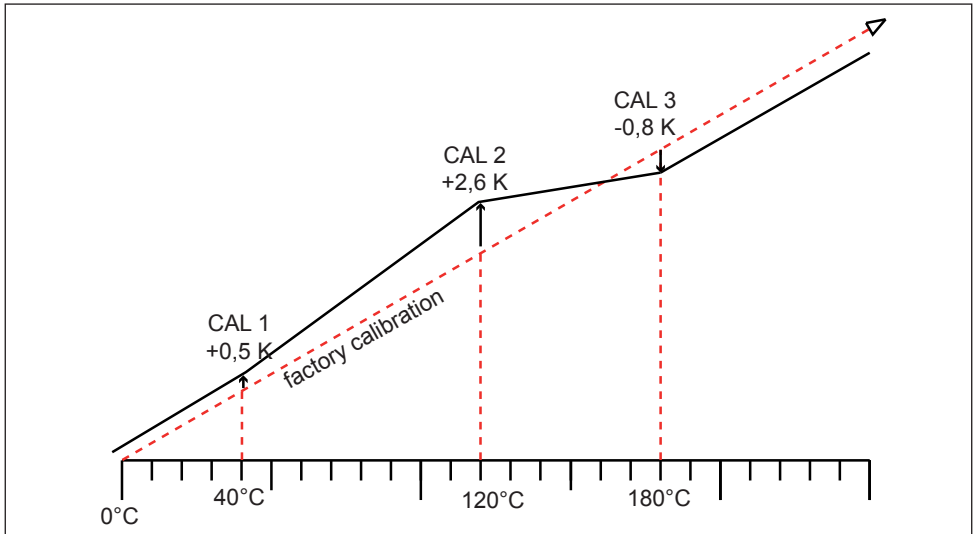

Fig. 38 Schematic example of temperature adjustment

Example: Temperature deviation at 120 °C should be corrected.

1. Activate the adjustment setting. To do so, press the activation key on the right of the TIME display. The display is enlarged and the first calibration temperature – in this case 40 °C – automatically highlighted.



2. Press the confirmation key repeatedly, until the calibration temperature Cal2 is selected.

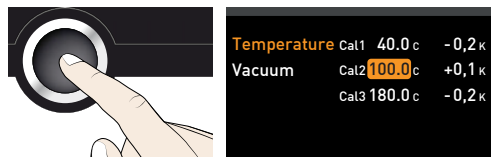

3. With the turn control, set the calibration temperature Cal2 to 120 °C.

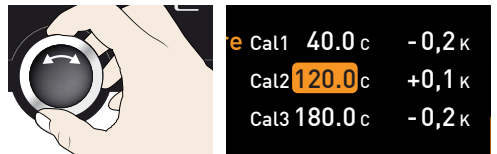

4. Save the setting by pressing the confirmation key. The corresponding calibration value is automatically highlighted.

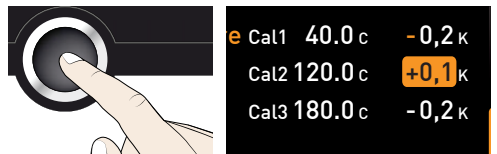

- Set the calibration value to 0.0 K and accept the setting by pressing the confirmation key.



- Place the sensor of a calibrated reference meter on the thermoshelf to be calibrated.
- Close the door and, in manual mode, adjust the set temperature to 120 °C.

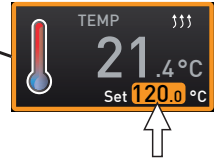
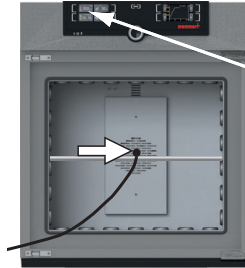

- Wait until the appliance reaches the set temperature and displays 120 °C. The reference instrument should display 122.6 °C.

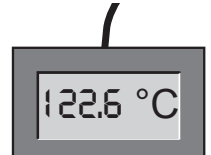
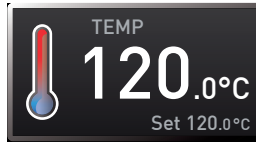

- In the SETUP, adjust the calibration value Cal2 to +2.6 K (actual value measured minus setpoint temperature) and save the setting by pressing the confirmation key.

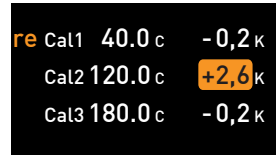

- After the calibration procedure, the temperature measured by the reference instrument should now also be 120 °C.

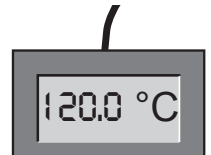
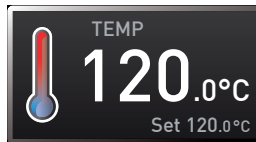

With Cal1, a calibration temperature below Cal2 can be programmed accordingly, and with Cal3, a temperature above. The minimum clearance between the Cal values is 20 K.

i If all calibration values are set to 0.0 K, the factory calibration settings are restored.

7.5.2 Pressure calibration

The pressure can also be calibrated using three selectable adjustment points. The minimum distance between the calibration points is 20 mb. The setting range is ± 20 mb.

For pressure adjustment, you will need a calibrated pressure reference measuring device.

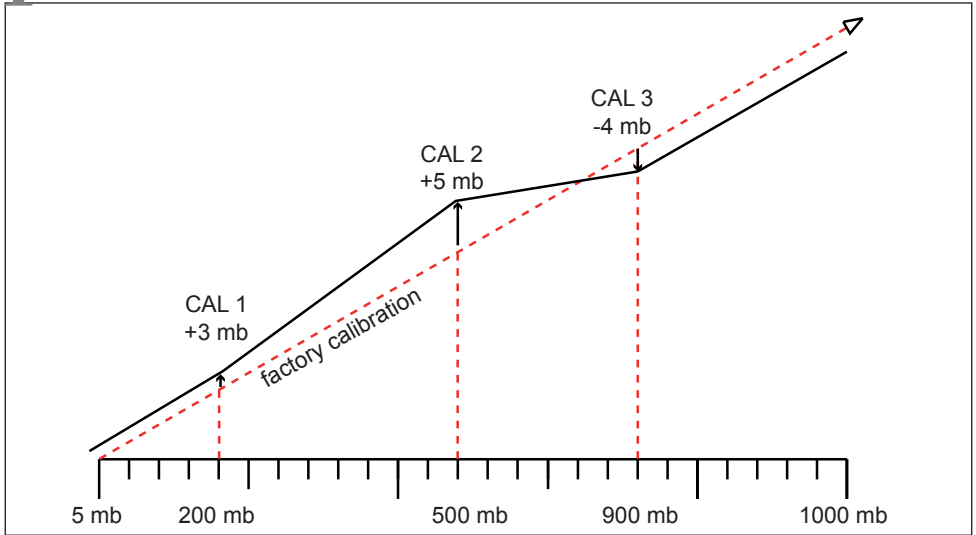

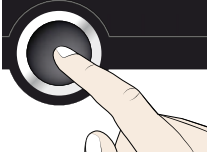

Fig. 39 Schematic example of pressure calibration

Example: Pressure at 600 mb is to be calibrated.

1. Connect the calibrated pressure gauge to the VO fresh air connection (see page 13) via ISO-KF connection size DN 16.
2. Activate the adjustment setting. To do so, press the activation key on the right of the TIME display. The display is enlarged.
 
3. Turn the turn control until Vacuum is highlighted.
 

Temperature	Cal1	50.0 mb	0.0 mb
Vacuum	Cal2	500.0 mb	+4.0 mb
	Cal2	950.0 mb	0.0 mb
4. Press the confirmation key repeatedly, until the calibration point Cal2 is selected.
 

Cal1	50.0 mb	0.0 mb
Cal2	500.0 mb	+4.0 mb
Cal2	950.0 mb	0.0 mb

5. With the turn control, set the calibration point Cal2 to 600 mb.



Cal1	50.0 mb	0.0 mb
Cal2	600.0 mb	+4.0 mb
Cal2	950.0 mb	0.0 mb

6. Confirm by pressing the confirmation key. The corresponding calibration value is automatically selected.

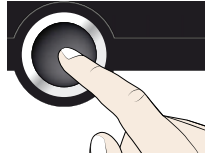

Cal1	50.0 mb	0.0 mb
Cal2	600.0 mb	+4.0 mb
Cal2	950.0 mb	0.0 mb

7. Set the compensation correction value to 0.0 mb and confirm with the confirmation key.



Cal1	50.0 mb	0.0 mb
Cal2	600.0 mb	0.0 mb
Cal2	950.0 mb	0.0 mb

8. In manual mode, set and activate set pressure to 600 mb.



9. Wait until the set pressure is reached and 600 mb is displayed.



10. Turn the turn control as far as possible to the right until Set open is displayed.

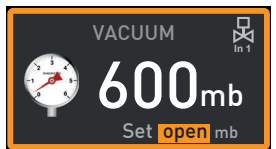

11. Read off the pressure from the reference instrument. It displays for example 607 mb.



12. In the SETUP, adjust the compensation correction value Cal2 to +7 mb (actual value measured minus setpoint value) and save the setting by pressing the confirmation key.



Cal1	50.0 mb	0.0 mb
Cal2	600.0 mb	+7.0 mb
Cal2	950.0 mb	0.0 mb

7.6 Program

In the Prog display, programs created using the AtmoCONTROL software can be transferred to the appliance and saved on a USB data storage medium. Here, you can also select the program to be used in manual mode (see page 38) and delete programs.

i To load a program from a USB storage medium : Connect the USB storage medium with the saved program(s) to the interface on the right side of the ControlCOCKPIT.

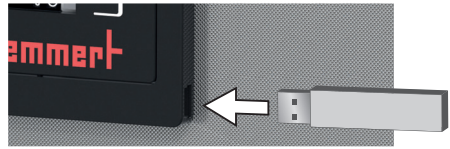

1. Activate the program display. To do so, press the activation key on the left of the Prog display. The display is enlarged and the entry **Select** automatically highlighted. The programs available for activation are shown on the right. The program currently available for use – in this example **Test 012** – is highlighted in orange.

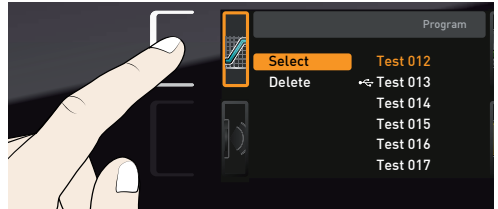

2. Access the **Select** function by pressing the confirmation key. All programs available are displayed, including the ones saved on the USB data storage medium (identified by the USB symbol). The program currently available for use is highlighted in orange.

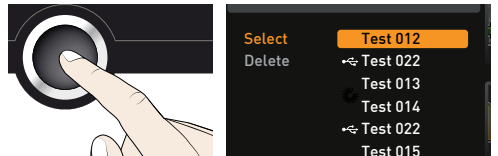

3. With the turn control, select the program you want to make available for use.

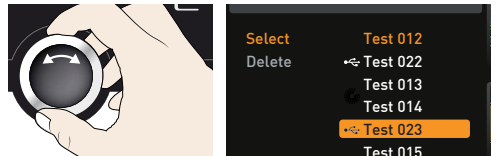

4. Accept the selection by pressing the confirmation key. The program is now loaded, which is indicated by the transfer symbol.

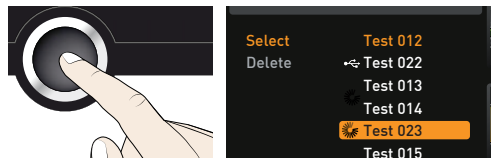

5. As soon as the program is ready, the selection returns to **Select** to start the program: Return to operating mode by pressing the MENU key, as described on page 36.

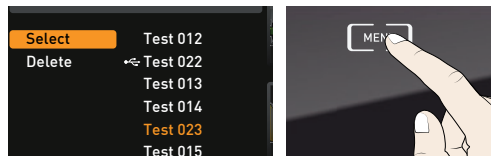

You can now remove the USB storage medium.

To delete a program, select **Delete** with the turn control and select the program to be deleted the same way you can select a program for activation.

7.7 Sounds

In the SOUND display, you can define whether or not the appliance should emit acoustic signals and, if yes, define on which events it should do so:

- ▶ on the press of a key
- ▶ at the end of a program
- ▶ On alarm
- ▶ if the door is open

1. Activate the acoustic signal adjustment. To do so, press the activation key on the left side of the SOUND display. The display is enlarged. The first category (in this case Keysound) is automatically highlighted. On the right, the current settings are shown on.

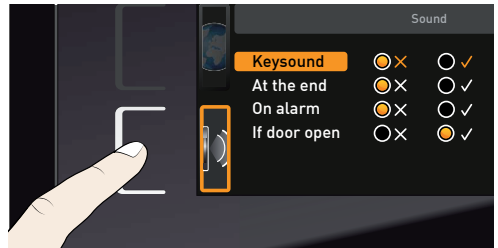

1. If you want to edit another list entry: Turn the turn control until the respective entry – e.g. if door open (special configuration) – is highlighted in colour.

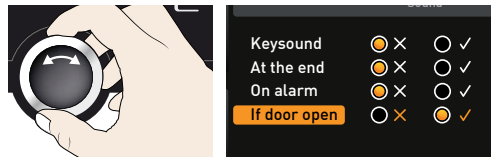

2. Save the selection by pressing the confirmation key. The adjustment options are automatically highlighted.

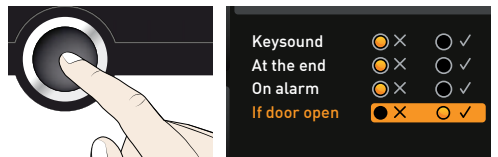

3. Select the desired setting with the turn control.

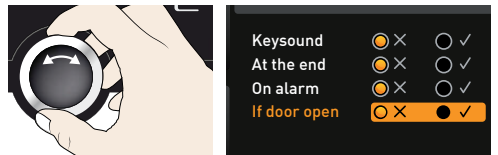

4. Save the setting by pressing the confirmation key.

1. If an acoustic alarm sounds, it can be turned off by pressing the confirmation key.

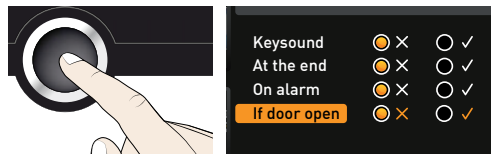

7.8 Logging

The appliance continually logs all relevant measured values, settings and error messages at 1-minute intervals. The internal log memory is of the continuous memory type. The logging function cannot be switched off and is always active. The measured data are stored in the appliance, safe from manipulation. If the power supply is interrupted, the time of the power failure and voltage recovery are stored in the appliance.

You can export the protocol data for different periods to a USB storage medium via the USB port or, via Ethernet, import them to the AtmoCONTROL software for graphical representation, print-out or storage.

i The log memory of the appliance is not modified or deleted by reading it out.

1. Connect the USB storage medium to the USB port on the right of the ControlCOCKPIT.

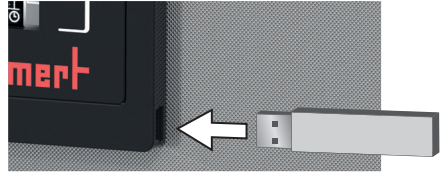

2. Activate the protocol. To do so, press the activation key on the right side of the PROTOCOL display. The display is enlarged and the period This month automatically highlighted.



3. Save your selection by pressing the confirmation key. The transfer starts and a status symbol indicates the progress.

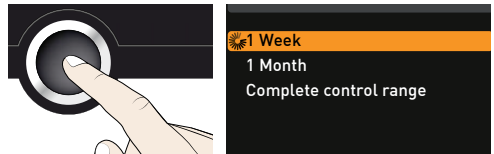

4. As soon as the transfer is complete, a check mark appears in front of the period selected. You can now remove the USB storage medium.

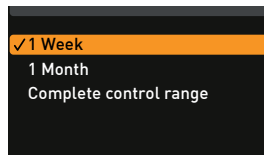

For a description of how to import and process protocol data in AtmoCONTROL or read it out via Ethernet, please refer to the separate AtmoCONTROL manual.

7.9 USER ID

7.9.1 Description

With the USER ID function, you can lock the settings of individual (e.g. temperature) or all parameters, so that they cannot be changed at the appliance by accident or unauthorised persons. You can also lock setting options in menu mode (e.g. adjustment or date and time settings) this way.

1 If adjustment options are locked, this is indicated by the lock symbol in the respective display (Fig. 40).

USER ID data is entered in the AtmoCONTROL software and saved on the USB storage medium. The USB storage medium is thus acting as a key: Parameters can only be locked or unlocked if it is connected.

1 A description of how to create a USER ID in AtmoCONTROL is provided in the separate AtmoCONTROL manual.

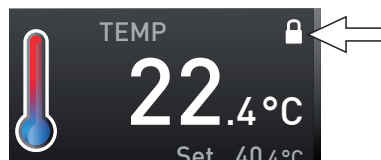
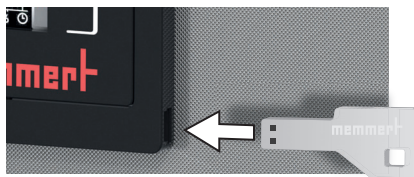

Fig. 40 Temperature adjustment at appliance locked (example)

7.9.2 USER ID activation and deactivation

1. Connect the USB storage medium with the USER ID data to the USB port on the right of the ControlCOCKPIT.



2. Activate the USER ID. To do so, press the activation key on the right side of the USER ID display. The display is enlarged and the entry Activate automatically highlighted.

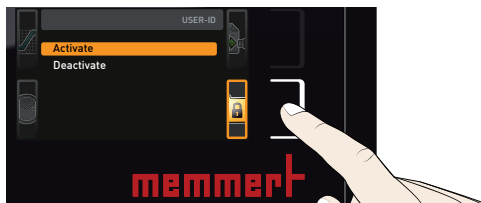

3. Confirm the activation by pressing the confirmation key. The new USER ID data are transferred from the USB storage medium and activated. As soon as activation is complete, a check mark appears in front of the corresponding entry.

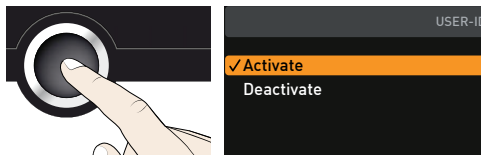

4. Remove the USB storage medium. Locked parameters are indicated by the lock symbol on the respective display (Fig. 40).

To unlock the appliance, connect the USB storage medium, activate the USER ID display and select the entry Deactivate.

8. Maintenance and Servicing

⚠ WARNING



Danger due to electric shock. Disconnect the mains plug before any cleaning or maintenance work.

⚠ CAUTION



Danger of cuts due to sharp edges. Always wear gloves when working in the interior of the chamber.

8.1 Cleaning

8.1.1 Interior and metal surfaces

Regular cleaning of the easy-to-clean interior prevents build up of material remains that could impair the appearance and functionality of the stainless steel chamber over time.

The metal surfaces of the appliance can be cleaned with normal stainless steel cleaning agents. Make sure that no rusty objects come into contact with the interior or with the stainless steel housing. Rust deposits can lead to an infection of the stainless steel. If rust spots should appear on the surface of the interior due to impurities, the affected area must be immediately cleaned and polished.

8.1.2 Plastic parts

Do not clean the ControlCOCKPIT and other plastic parts of the appliance with caustic or solvent-based cleaning agents.

8.1.3 Glass surfaces

Glass surfaces can be cleaned with a commercially available glass cleaner.

8.2 Regular maintenance

Once a year, grease the moving parts of the doors (hinges and lock) with thin silicone grease and check that the hinge screws are not loose.

To guarantee perfect control, we recommend calibrating the appliance once a year (see page 55).

8.3 Repairs and Service

⚠ WARNING



After removing covers, live parts may be exposed. Touching these can lead to an electric shock. Disconnect the mains plug before removing any covers. Work on the electrical system must only be performed by qualified electricians.



Repairs and service work are described in a separate service manual.

9. Storage and disposal

9.1 Storage

The appliance may only be stored under the following conditions:

- ▶ in a dry and enclosed, dust-free room
- ▶ frost-free
- ▶ disconnected from the power supply

9.2 Disposal

This product is subject to Directive 2002/96/EC on Waste Electrical and Electronic Equipment (WEEE) of the European Parliament and of the Council of Ministers. This appliance was placed on the market after 13 August 2005 in countries which have already integrated this Directive into their national laws. It may not be disposed of in normal household waste. For disposal, please contact your dealer or the manufacturer. Any appliances that are infected, infectious or contaminated with materials hazardous to health are excluded from return. Please also observe all other regulations applicable in this context.

Before disposing of the appliance, please render the door locking mechanism unusable, for example to prevent playing children from being locked inside the appliance.

There is a lithium battery in the ControlCOCKPIT of the appliance. Remove it and dispose of it in accordance with the regulations in your country (Fig. 41).

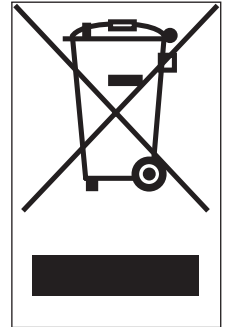

Fig. 41 Removing the lithium battery

Index

- A**
- Accessories 18
 - Activation button 32
 - Adjusting doors 24
 - Adjustment 54
 - Alarm 38, 39, 41, 44
 - Ambient temperature 18
 - Appliance error 45
 - ASF 37, 39
 - AtmoCONTROL 3, 14, 18, 33, 36, 59, 61, 62
- B**
- Basic appliance settings 48
 - Basic settings 48
- C**
- CALIB 55, 57
 - Calibration 54
 - Cause of error 45
 - Chamber load 31
 - Changes 8
 - Cleaning 63
 - Communication interfaces 14
 - Compensation correction values 56
 - Connections 12
 - ControlCOCKPIT 9, 32
 - Customer service 2
- D**
- Date 53
 - Declaration of conformity 17
 - Delete programme 59
 - Delivery 19, 20, 25
 - Digital backwards counter with target time setting 35
 - Dimensions 17
 - Disposal 64
 - Door 30
 - Doors 24
- E**
- Electrical connection 12
 - Electronic temperature monitoring 38
 - Emergency 8
 - Ending operation 43
 - End of program 37
 - Error description 45
 - Error messages 44
 - Ethernet 14
 - Explosion protection 10
- F**
- Flush valve 14, 15
 - Forklift truck 20
 - Fresh air supply 13, 26
- G**
- Gas bottles 7
 - Gas connection 34
 - Gas inlet 51
 - Graph 42
- H**
- Hazards 6
- I**
- Inert gas 10, 11, 13
 - Inert gas connection 13, 26
 - Installation site 21
 - Intended use 8, 10
 - Interfaces 12
 - IP address 50
- K**
- Keysound 60
- L**
- Language selection 49
 - Lifting equipment 19, 20
 - Loading the appliance 30
 - Log memory 47, 61
 - low 34
- M**
- Maintenance 63
 - Malfunctions 8, 44
 - Manufacturer 2
 - Materials 12
 - Mechanical temperature monitoring 39
 - Menu 48
 - Minimum clearances 21
 - Monitoring temperature 38
- N**
- Network 14, 50
 - Normal mode 33, 34
- O**
- Open 34
 - Opening the door 30
 - Operating modes 33
 - Operating personnel 7, 30
 - Operating problems 45
 - Operation 30
- P**
- Packaging gas 13
 - Packaging material 20
 - Parameter adjustment 32, 49
 - Power failure 47
 - Power supply 61
 - Pressure 34
 - Pressure calibration 57
 - Pressure monitoring 41
 - Pressure pattern 43
 - Product safety 6
 - Prog 59
 - program 59
 - Program mode 33, 36
 - Protocol 61
 - PT100 temperature sensor 38
 - Pump control 14
 - Pump module 9, 10, 11, 13, 15
 - Putting into operation 25
- R**
- Regular maintenance 63
- S**
- Safety regulations 6, 9
 - Service 63
 - Servicing 63
 - Setting up 19, 21
 - Setting up options 22
 - Setup 50
 - Sound 60
 - SOUND 60
 - Speaker symbol 38, 41, 44
 - Storage after delivery 20
 - Suction 7, 8

Switching off 43
Switching on 29
Switching output 14

T

Taking out of service 64
TB 39
Technical data 16
Temperature 34
Temperature deviation 55
Temperature limiter 39
Temperature monitor 37,
39
Temperature monitoring
37
Temperature sensor 38
Thermoshelves 9, 10, 11,
12, 16, 18
Tilt protection 23
Time 53
Timer 35
Timer mode 52
Transport 19, 20
Transport damage 20
Troubleshooting 45
Turn control 33
TWW 38
TWW temperature monitor-
ing 38
Type plate 15

U

Unit 51
Unpacking 20
USB interface 14, 61
USER ID 62

V

Vacuum pump 10, 11, 13,
14, 15, 26
Vacuum pump connection
13, 26

W

Warning messages 14, 44
Weight 16

memmert

Vacuum oven VO

D39374 | Date 05/2022

English

Memmert GmbH + Co. KG
Postfach 1720 | D-91107 Schwabach
Tel. +49 9122 925-0 | Fax +49 9122 14585
E-Mail: sales@memmert.com
facebook.com/memmert.family